

ROTALIGN[®] Ultra iS

Operating handbook - Shaft alignment



A user's handbook

Dear Customer,

Welcome to the world of intelligent shaft alignment using ROTALIGN Ultra iS Shaft, another innovative product from PRÜFTECHNIK, the inventors of laser shaft alignment. This handbook sets out to help the instrument user work through the instrument with the required ease. It is the standard work for both the 'Advanced Shaft' and 'Standard Shaft' versions, and meant to be a quick learning tool that hopefully should make compelling reading.

PRÜFTECHNIK Alignment Systems GmbH

Freisinger Str. 34

85737 Ismaning

Germany

Tel +49.89.99616-0

Fax +49.89.99616-100

Email info@pruftechnik.com

Edition January 2014

Part number DOC 40.200.en

Firmware version 3.xx

sensALIGN® and ROTALIGN® are registered trademarks of PRÜFTECHNIK Dieter Busch AG. PRÜFTECHNIK products are the subject of patents granted and pending throughout the world. Contents subject to change without further notice, particularly in the interest of further technical development. Reproduction, in any form whatsoever, only upon express written consent of PRÜFTECHNIK Alignment Systems GmbH.

© Copyright 2014 by PRÜFTECHNIK Alignment Systems GmbH



Foreword

ROTALIGN Ultra iS is industry's first intelligent alignment system. The system combines the features of the tested and proven ROTALIGN Ultra iS computer together with those of the next generation sensALIGN sensor and laser. ROTALIGN Ultra iS computer features a 5.7-inch (145 mm) colour TFT sunlight readable full VGA screen, a fast processor, an alphanumeric keyboard with strategically placed navigation keys that handles all data entry functions, a long lasting rechargeable battery, handy on-screen context menu, a remarkable file storage capacity and computer LEDs that give the instant status of the alignment condition and laser beam adjustment.

sensALIGN sensor possesses an unlimited detector range making it possible to measure grossly misaligned machines or those with long couplings. Both sensor and laser incorporate Micro Electro Mechanical System (MEMS) allowing the measurement of component rotational angle and vibration. sensALIGN sensor incorporates Bluetooth for wireless transmission of measurement data to the system computer. Both sensor and laser are powered using Lithium Polymer (Li-Po) rechargeable batteries.

In its completeness, the system handles the alignment of drive trains comprising up to 14 machines and includes intelligent features such as ellipse calculation, monitoring environmental vibration, live measurement quality and suppression of coupling backlash.

If you have any suggestions for improvement or corrections (not just to this manual, but also for hardware), please drop us a line. We would be glad to make improvements wherever possible.

We look forward to hearing from you.

PRÜFTECHNIK Alignment Systems
Ismaning, Germany

Contents

Foreword	2
Chapter 1: ROTALIGN Ultra iS Shaft package	5
1.1 ROTALIGN Ultra iS Shaft package ALI 40.000	5
Chapter 2: System description	11
2.1 Safety notes	11
2.2 Getting to know the ROTALIGN Ultra iS computer	14
2.3 sensALIGN laser ALI 4.910	20
2.4 sensALIGN sensor ALI 4.900	23
2.5 Handling precautions	25
Chapter 3: Getting started with the ROTALIGN Ultra iS Shaft system	27
3.1 ROTALIGN Ultra iS Shaft system composition	27
3.2 Obtaining alignment readings in quick intelligent steps	27
3.3 Tips and tricks	32
Chapter 4: Shaft alignment application	35
4.1 Starting the shaft alignment application	35
4.2 Horizontal machine alignment - preparing for the alignment procedure	36
4.3 Check soft foot	37
4.4 Mount the brackets	37
4.5 Mount sensALIGN laser and sensor	39
4.6 Switch ROTALIGN Ultra iS on and start application	40
4.7 Enter machine dimensions	41
4.8 Machine properties	42
4.9 Coupling properties	47
4.10 Flipping machines	52
4.11 Laser beam adjustment	54
4.12 Taking measurements	56
4.12a Taking measurements using the sensALIGN sensor and laser cable	60
4.13 Results	61
4.14 Align machine	67
4.15 Saving and printing measurement files	75
4.16 Alignment completion	82
Chapter 5: Alignment features	83
5.1 Measurement modes	83
5.2 Measurement options	97
5.3 Measuring vibration	118
5.4 Set-up options	123
5.5 Soft foot	133

Chapter 6: Special alignment applications 141

6.1 Machine train alignment 141

6.2 Cardan shaft alignment 147

6.3 Flanged machines 155

6.4 Flange-mounted horizontal machines..... 165

Chapter 7: Updating ROTALIGN Ultra firmware 171

7.1 Updating ROTALIGN Ultra firmware to higher version..... 171

Chapter 8: ROTALIGN Ultra iS Shaft configuration 177

8.1 Configuration 177

8.2 User accounts 191

8.3 Creating templates 198

8.4 Deleting created templates from the program manager 200

8.5 Available applications and options 202

8.6 Upgrading from Standard Shaft to Advanced Shaft version 204

Appendix 207

Suggested shaft alignment tolerances 207

ROTALIGN Ultra iS technical data 209

sensALIGN sensor and laser 'ON/OFF/CHARGE' workflow..... 211

Declaration of conformity 212

Index 213

Chapter 1: ROTALIGN Ultra iS Shaft package

ALI 40.000 is the ROTALIGN Ultra iS Advanced Shaft package.

For details of other available ROTALIGN Ultra iS stand-alone and add-on packages, please contact your local PRÜFTECHNIK sales representative.

ALI 40.000-L is the ROTALIGN Ultra iS Standard Shaft package.



Note

1.1 ROTALIGN Ultra iS Shaft package ALI 40.000

ALI 4.820

ROTALIGN Ultra iS Shaft case

ALI 4.202

ROTALIGN Ultra iS computer including:

ROTALIGN Ultra iS rechargeable battery

ALI 4.603

ROTALIGN Ultra iS stand ALI 4.201

ALI 4.910

sensALIGN laser [sensALIGN rechargeable battery ALI 4.960 is mounted]

ALI 4.900

sensALIGN sensor [sensALIGN rechargeable battery ALI 4.960 is mounted]



ALI 4.820

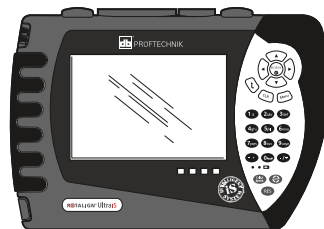

ALI 4.202

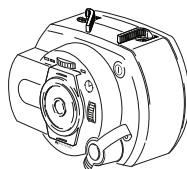

ALI 4.910

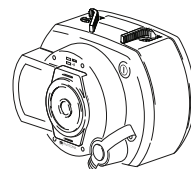

ALI 4.900

ALI 4.921-2 sensALIGN sensor and laser cable

ALI 4.651-I sensALIGN charger/adaptor (universal)
– for powering and charging sensALIGN sensor/laser and rechargeable battery

ALI 12.502-2 PC/USB cable

ALI 12.503 USB/peripheral devices cable

ALI 12.651-I AC power supply/charger (universal) – for powering and charging ROTALIGN Ultra iS computer and rechargeable battery

CAUTION: The universal mains adapter is supplied with plugs for the EU, US and UK. Care must be exercised when changing the plugs. Please refer to the plug mounting procedure in section 2.2.5.



ALI 12.502-2

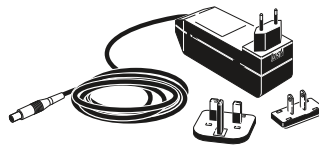

ALI 12.651-I



ALI 4.921-2

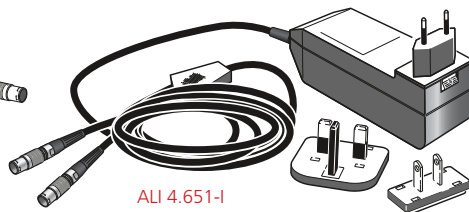

ALI 4.651-I



ALI 12.503

ALI 2.113 SET

Compact chain-type bracket set

includes: chains — ALI 2.114, ALI 2.115,
support posts — ALI 2.170, ALI 2.171,
ALI 2.172, ALI 2.173, ALI 2.174 and storage
pouch — ALI 3.590-200

ALI 2.905

Lens cleaning cloth

ALI 3.588

Tape measure mm/inch

DOC 40.100.en

ROTALIGN Ultra iS Shaft pocket guide

DOC 40.200.en

**ROTALIGN Ultra iS Shaft
operating instructions**

DOC 40.900.en

ROTALIGN Ultra product catalog

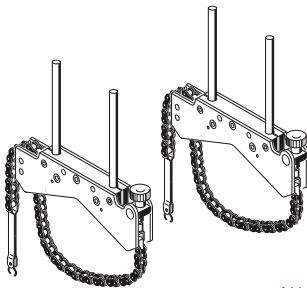

ALI 2.113 SET

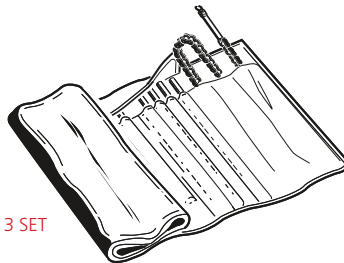

ALI 2.905



ALI 3.588



DOC 40.900.en



DOC 40.200.en

DOC 40.100.en

ALI 13.700 CD

ALIGNMENT CENTER CD

ALI 4.741

ROTALIGN Ultra Advanced Shaft
Firmware registration certificate
(not shown)

ALI 4.905

Vibration check probe

ALI 4.451

USB memory stick

0 0739 1055

Allen key (2.5 mm)



0 0739 1055



ALI 4.905



ALI 13.700 CD



ALI 4.451

1.1.1 Optional ROTALIGN Ultra iS components

ALI 4.605 ROTALIGN Ultra iS disposable battery housing

ALI 4.615 Desktop charging station for ROTALIGN Ultra iS rechargeable battery

ALI 4.615 SET Desktop charging station set for ROTALIGN Ultra iS rechargeable battery includes:
Desktop charging station **ALI 4.615**
ROTALIGN Ultra iS rechargeable battery **ALI 4.603**

ALI 4.410 Dust cap for computer sensor socket

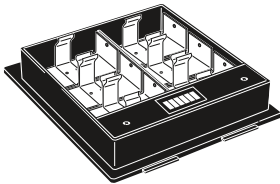

ALI 4.605

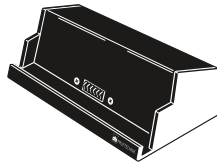

ALI 4.615



ALI 4.603

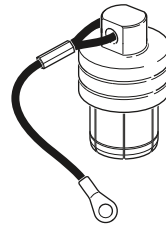

ALI 4.410

This page intentionally left blank

Chapter 2: System description

2.1 Safety notes

ROTALIGN Ultra iS is to be used in industrial environments only for alignment of turbine components, shafts, bores, measurement of straightness and flatness of different surfaces. It is dust proof and water resistant with a rating of IP 65. Although shockproof, care must be taken to ensure that the instrument is not subjected to mechanical knocks. ROTALIGN Ultra iS must be operated only by properly trained personnel. No liability will be assumed when components or operating procedures as described in this manual are altered without permission of the manufacturer.

Note that the necessary application firmware [bore alignment, flatness, straightness among others] must be purchased, installed and licenced.

2.1.1 Symbols used in this handbook

The following symbols are used in this manual in order to draw the reader's attention to especially important text, such as possible sources of danger or useful operating tips.

This symbol denotes general information and tips regarding operation of ROTALIGN Ultra iS.

This symbol denotes information which must be followed in order to avoid damage to equipment.

This symbol denotes information which must be followed in order to avoid personal injury.

Numbers in red circles indicate the corresponding operating step described in these instructions and must be performed exactly.



Note



CAUTION



WARNING

1

2.1.2 CE compliance and electromagnetic compatibility

ROTALIGN Ultra iS fulfills the EC Guidelines for electric devices and those relating to electromagnetic compatibility as indicated in the conformity certificate attached in the appendix. The certificate may also be downloaded from the PRÜFTECHNIK website.

2.1.3 Laser safety

The ROTALIGN Ultra iS system uses sensALIGN laser ALI 4.910. According to IEC 60825-1, sensALIGN laser is classified as a Class 2 laser product. The laser operates at 635 nm and has a maximum radiant power <1 mW. It complies with the FDA specifications 21 CFR 1040.10 and 1040.11 except for deviations pursuant to laser notice No. 50, dated June 24, 2007. No maintenance is necessary to keep this product in compliance with the specifications referred to.

- ▶ Do not look directly into the laser beam at any time. (The natural blink reaction of the human eye is normally sufficient to protect the eyes from any dangers posed by looking at the laser beam briefly. But as natural blink reaction may fail to occur, care should be taken to avoid staring into the beam.)
- ▶ Do not insert any optical devices into the beam path.
- ▶ The red LED on the front of sensALIGN laser illuminates whenever the laser beam is emitted.
- ▶ CAUTION – Use of controls or adjustments or performance of procedures other than those specified herein may result in hazardous radiation exposure.



WARNING



CAUTION

2.1.4 Component labelling

The labelling diagram below represents both sensALIGN sensor and sensALIGN laser. The diagram shows the engraved symbols, markings and labels as they appear on the respective measurement head. The laser safety labels are affixed on the housing of sensALIGN laser at the positions shown in the diagram. The rechargeable battery label is located on the rear of sensALIGN rechargeable battery.

This symbol is engraved on the top of both sensALIGN laser and sensor, and indicates the direction of the clamping levers open position.



The black label is on the back of sensALIGN rechargeable battery ALI 4.960 which is mounted on both sensALIGN laser ALI 4.910 and sensALIGN sensor ALI 4.900.

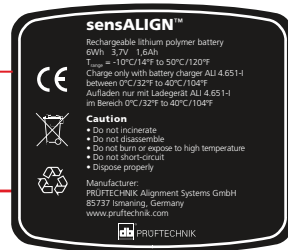

This label is found on the side of sensALIGN laser ALI 4.910.



This label is found on the side of sensALIGN laser ALI 4.910.



This circular label is located on the outside of the sensALIGN laser aperture.



This symbol is engraved on the side of sensALIGN sensor next to the countersunk hole, and indicates the position to place the vibration check probe ALI 4.905

In this example, the next calibration due date is May 2016.



The part number, serial number and date of manufacture are engraved at the bottom of both sensALIGN sensor and laser. The service and calibration label is also attached at the bottom of the units.



The above label is affixed on the back of ROTALIGN Ultra iS computer ALI 4.202.

The label opposite is on the back of ROTALIGN Ultra iS computer, affixed to the rechargeable battery in current use.

2.2 Getting to know the ROTALIGN Ultra iS computer

The ROTALIGN Ultra iS computer has been developed to effectively handle both simple and complex shaft, bore and turbine diaphragm applications. The computer is also used to carry out straightness and flatness measurements. ROTALIGN Ultra iS has a customer-oriented user interface. It uses easy-to-follow icons and comprehensive on-screen menus and hint texts, that enable even first-time users to operate the computer without difficulty.

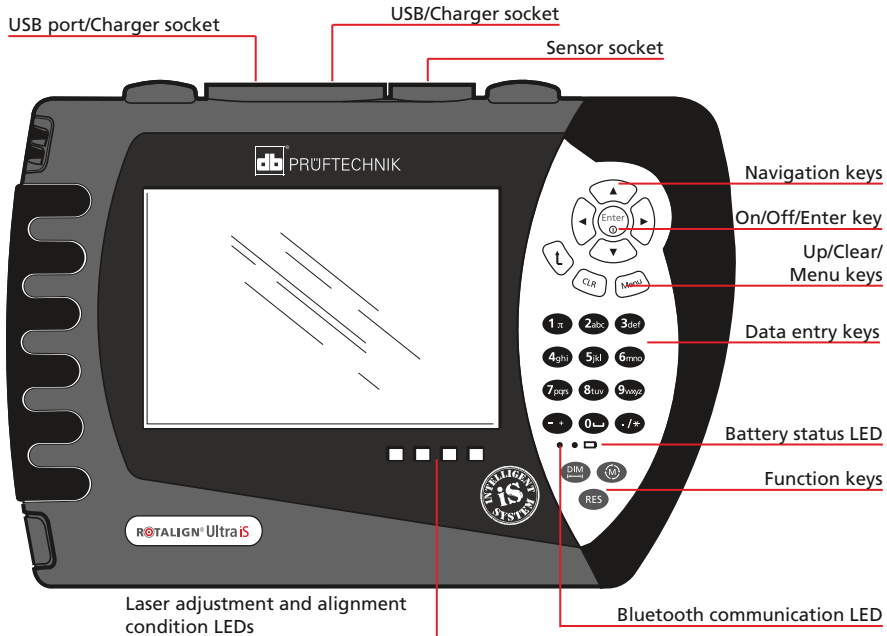

ROTALIGN Ultra iS is built to rugged industrial standards of shock and water resistance. It contains a complete computer with a 5.7 inch (145 mm) color TFT full VGA display, oval-shaped function and data entry keys, 4-way navigation keys, an On/Off/Enter key, an up key, a clear key and a menu key.

2.2.1 Operating keys

- ▶ The navigation keys are used to navigate through the menu and display items.
- ▶ The 'On/Off/Enter' key is used to perform four functions – switching ROTALIGN Ultra iS on/off, and accessing any selected item or confirming an action. To switch on/off, press and hold , the 'On/Off/Enter' key briefly.
- ▶ The 'Up' key is used as a back/return key, taking user to previously selected function, or to exit current screen.
- ▶ The 'CLR' (Clear) key is used to delete information entered inadvertently.
- ▶ The 'Menu' key is used to call-up menu options related to the selected display screen. Pressing it twice brings up the global menu.
- ▶ The data entry keys are used to enter relevant data.

ROTALIGN Ultra iS possesses 3 function keys.

- ▶ The 'Dimension' key is used to access machine set-up where machine dimensions and properties are defined.
- ▶ The 'Measurement' key is used to access the measurement screen.
- ▶ The 'Result' key is used to call alignment results into the display.



2.2.2 Computer LEDs

- ▶ The battery status LED blinks green during the battery recharging process, staying steady green when battery is fully charged.
- ▶ The Bluetooth communication LED blinks blue while searching the neighbourhood for Bluetooth devices, staying steady blue when connected to the sensALIGN sensor.
- ▶ The four alignment condition LEDs are used to indicate the position of the laser beam on the detector during beam adjustment, and the actual alignment status after measurement.

LED	Laser beam adjustment	Alignment status
Blue	Laser beam centred	Excellent
Green	Laser beam OK	Acceptable
Amber	Laser beam out of recommended measurement part of detector	Bad
Red	Laser beam off	Grossly misaligned

2.2.3 Power supply

ROTALIGN Ultra iS is powered using a 7.2 V 6.0 Ah Lithium-ion rechargeable battery ALI 4.603, which is to be charged only using the battery charger ALI 12.651-I. This can be done with the battery inside the computer. The computer may continue to be used if the battery is charged inside it.

Alternatively, use 6 standard 'C' size [IEC LR 14] batteries contained in the optional battery compartment ALI 4.605.

If the ROTALIGN Ultra iS computer is not in use for extended periods of time, a month or more, the rechargeable battery or the standard batteries should be removed from the unit.



2.2.4 Replacing batteries

The rechargeable battery ALI 4.603 and the battery housing ALI 4.605 have identical shapes and are therefore replaceable. If batteries require removal, turn over the computer taking care not to damage the display and the hard keys. Undo the two screws by turning them counterclockwise a quarter of a turn. With the screws loosened, lift and pull the rechargeable battery or the battery housing (depending on power supply source) out. The reverse procedure is used to mount back the rechargeable battery or the battery housing back into the computer.

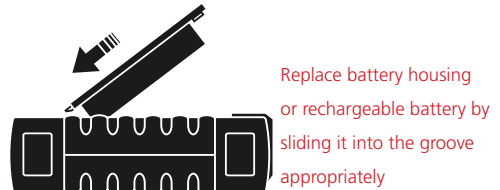
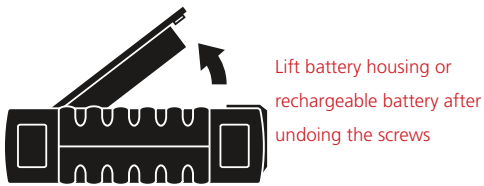

6 'C' size [IEC LR 14]
batteries

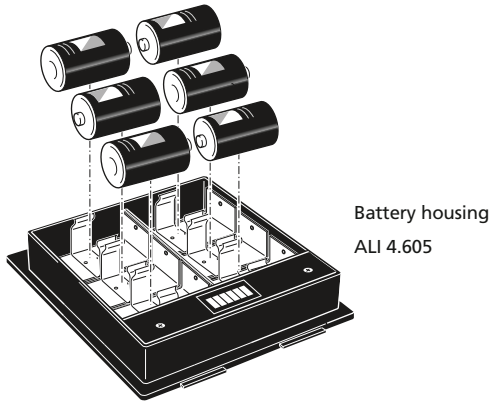

If you are using the standard 'C' size batteries, it is recommended to replace all of them at once. Note the battery polarity when inserting them in the battery housing ALI 4.605. The housing is removed and replaced in the same manner as the rechargeable battery ALI 4.603

2.2.5 Mounting and dismounting the AC power supply/charger plug

The AC power supply/charger ALI 12.651-I comes with three different regional plugs. The available plugs are for the Euro zone, the US, and the UK. When mounting or dismounting a plug, pay attention to the direction of the arrow on the plug just above the pins, and the arrow on the latching nipple on the charger housing.

To dismount a plug, push the latching nipple in the forward direction [1] as indicated by the arrow on it and hold, then push the plug to the right [2] as on the arrow on the plug.

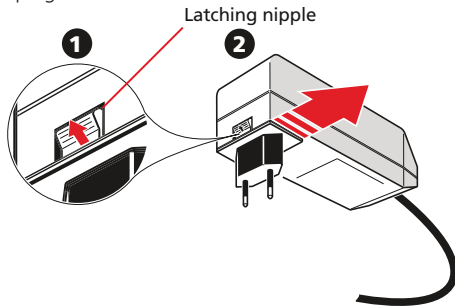

The direction arrow on the plug has the inscription 'OPEN' marked above it.

To mount a plug, push the latching nipple in the forward direction [1] as indicated by the arrow on it then slip the plug into the protruding prongs and slide it to the left until it latches.

ROTALIGN Ultra iS top panel connectors

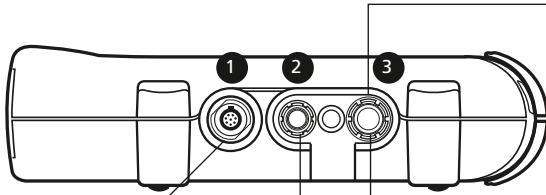

Sensor socket

Ensure correct sensALIGN sensor cable (ALI 4.921-2) plug orientation to avoid damaging pins

USB host/charger socket

The red dot on the charger plug must match the red dot on the battery socket

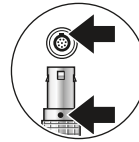

**USB host/slave port/
charger socket**

The red dot on the USB cable plug must match the red dot on the USB port

Note that available cables may be connected to the corresponding numbered sockets as follows:

- 1 ALI 4.921-2 (sensALIGN sensor and laser cable)
- 2 ALI 12.503 (short USB cable), ALI 12.651-I (charger)
- 3 ALI 12.502 (long USB cable), ALI 12.503(short USB cable), ALI 12.651-I (charger)

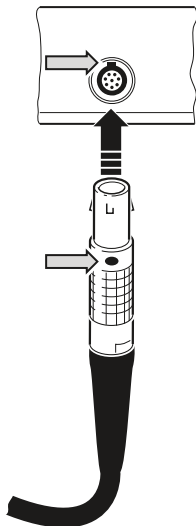

Connecting the battery charger to ROTALIGN Ultra iS computer – The LED next to the battery symbol on the keypad blinks while charging takes place.

2.3 sensALIGN laser

ALI 4.910

The semiconductor laser diode emits a ray of red light (wavelength 635 nm) which is visible where it strikes a surface. The Class 2 laser beam is emitted with a diameter of approx. 5 mm (3/16”).

sensALIGN laser is turned on by pressing and holding the on/off switch briefly. The “beam active” LED lights red.



With sensALIGN laser on, DO NOT stare into the laser beam!



WARNING

The beam is adjusted during set-up by changing its vertical and horizontal angles using the position thumbwheels, so that the beam strikes the sensALIGN sensor lens perpendicular to the lens surface.

sensALIGN laser is water and dust resistant (IP 65). The internal optics and electronics are internally sealed, preventing possible contamination.

Information regarding the battery status, the rotational angle, the temperature and the serial number of the sensALIGN laser are transmitted through the laser beam into sensALIGN sensor. This information is further relayed to ROTALIGN Ultra is computer. sensALIGN laser ALI 4.910 is powered using sensALIGN rechargeable battery ALI 4.960 a 3.7 V 1.6 Ah Lithium Polymer rechargeable battery. The rechargeable battery is attached to the laser and is to be charged only using the sensALIGN charger/adapter ALI 4.651-I, and is possible only when the battery is attached to the laser.

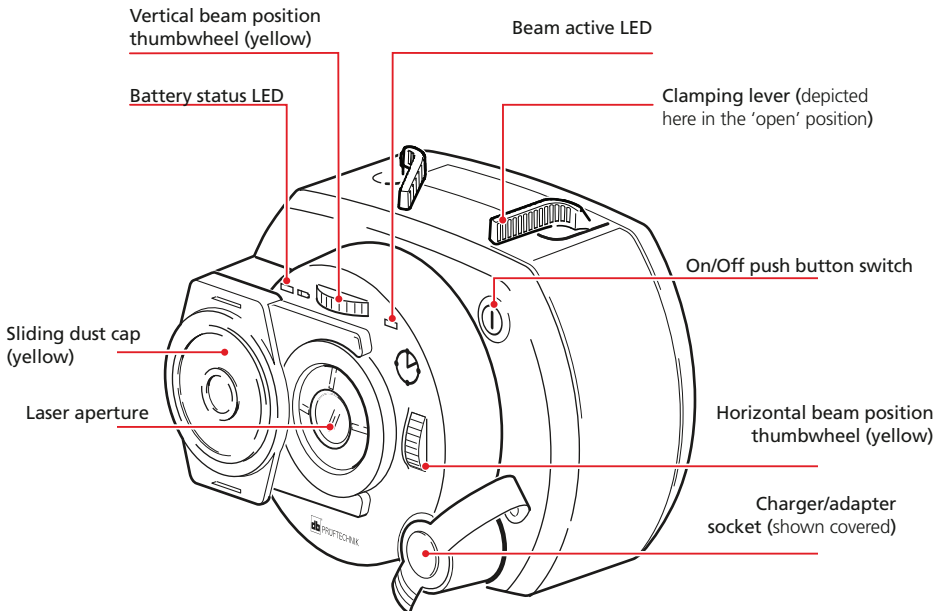

2.3.1 sensALIGN rechargeable battery ALI 4.960

Both sensALIGN laser ALI 4.910 and sensALIGN sensor ALI 4.900 are powered using the sensALIGN rechargeable battery ALI 4.960. The battery is charged via the charger/adaptor socket using the sensALIGN charger/adaptor ALI 4.651-I. If the battery capacity is greater than 50% [acceptable capacity for measurement], the battery status LED on both sensALIGN laser and sensor lights up green for 2 seconds on switching on.

During the charging process, the battery status LED blinks green. When the battery is fully charged, the LED lights steady green if the charger remains connected.

Activity	sensALIGN laser battery status LED	sensALIGN sensor battery status LED	sensALIGN laser beam active LED
Switch on	<p>Lights up green for 3 seconds when battery run time is > 10 hrs</p> <p>Blinks green every 3 seconds when battery run time is between 5 – 10 hrs</p> <p>Blinks red every 3 seconds when battery run time is between 1 – 5 hrs</p> <p>Blinks red constantly when battery run time is < 1 hr</p>	<p>Lights up green for 3 seconds when battery run time is > 10 hrs</p> <p>Blinks green every 3 seconds when battery run time is between 1 – 5 hrs</p> <p>Blinks red every 3 seconds when battery run time is insufficient for longer measurements</p> <p>Blinks red constantly when battery run time is < 1 hr</p>	<p>Lights steady red when in beam finder mode</p> <p>Blinks red when in measurement mode</p> <p>Note that measuring can take place with both modes</p>
Charging battery	<p>Blinks green when charging</p> <p>Lights steady green when fully charged</p> <p>Lights red when a failure occurs during charging</p>	<p>Blinks green when charging</p> <p>Lights steady green when fully charged</p> <p>Lights red when a failure occurs during charging</p>	LED off

To replace the rechargeable batteries, use the provided 2.5 mm allen key [0 0739 1055] to undo the two hex screws that affix the battery to either sensALIGN laser or sensor.

Used batteries should be disposed of in an environmentally-sound manner!



The position and removal of sensALIGN rechargeable battery ALI 4.960 is identical in both sensALIGN laser ALI 4.910 and sensALIGN sensor ALI 4.900.

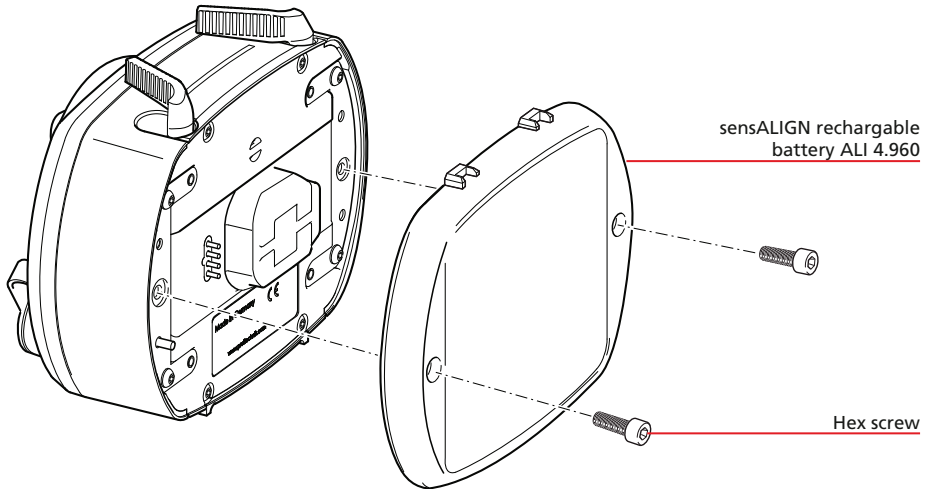

2.4 sensALIGN sensor ALI 4.900

sensALIGN sensor contains two position detectors, which measure the exact position and inclination of the laser beam as the shafts are rotated. Integrated in the sensor is Bluetooth technology for wireless transmission of measurement data to ROTALIGN Ultra iS computer. sensALIGN sensor also transmits sensALIGN laser data to the computer. The intelligent sensALIGN sensor technology is used to determine shaft rotational angle and machine vibration.

Positioned at the front of sensALIGN sensor are following indicator LEDs:

- › Battery status LED
- › Bluetooth communication LED
- › Four beam adjustment LEDs

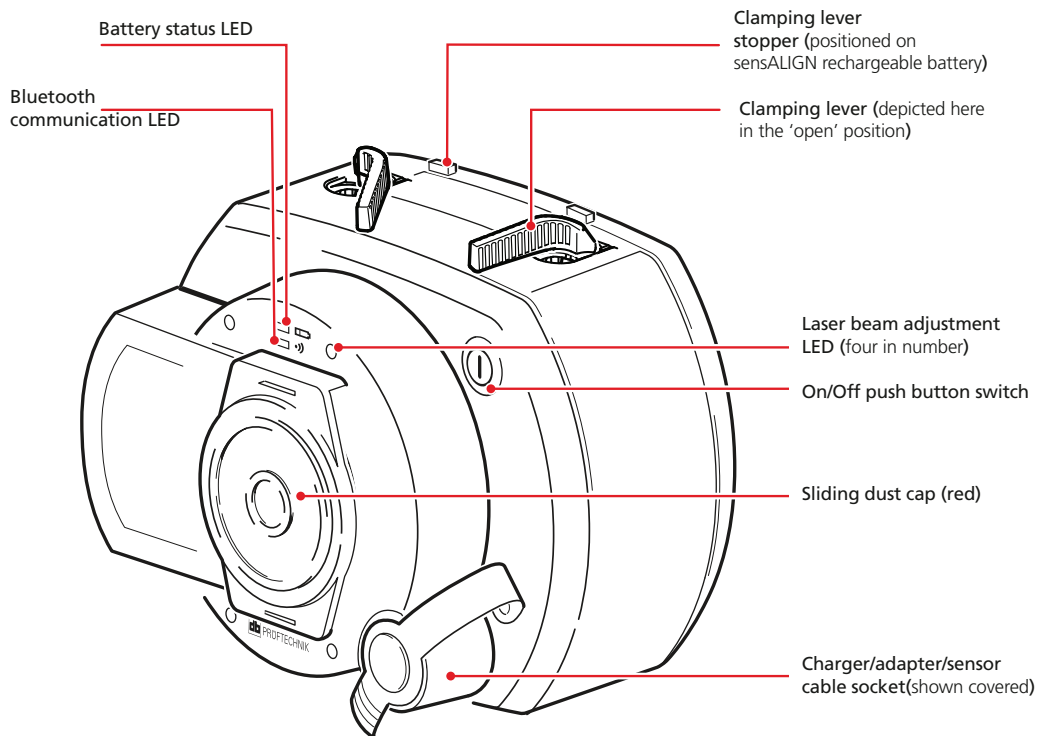

2.4.1 Understanding the beam adjustment LEDs

The four beam adjustment LEDs provide additional help when adjusting the laser beam position on sensALIGN sensor position detectors. The LEDs indicate the angle and position at which the laser beam enters the sensor. The LEDs blink either red or green depending on the angle at which the laser beam strikes the sensor. Green indicates a small angle while red indicates a large angle that must be corrected before beginning measurement.

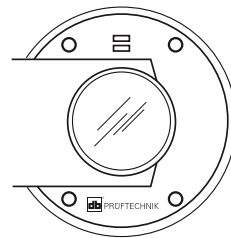

Activity	Laser beam adjustment LEDs
Switch on sensALIGN sensor	All four LEDs light up red then continue to blink every two seconds
Laser beam striking dust cap [laser off]	All four LEDs blink red every second
Laser beam entering sensor with a large angular deviation	One or more LEDs blinks red every second
Laser beam entering sensor with little or negligible angular deviation but with an offset	All four LEDs blink green twice every second
Laser beam entering sensor with neither appreciable angular deviation nor offset	All four LEDs blink green every second



All four LEDs blink red every second when the laser beam enters the sensor with a large angular deviation and offset.



When one or more LEDs blinks red every second, the laser beam is entering the sensor with a large angular deviation that must be corrected.



When all four LEDs are blinking green twice every second, the laser beam is entering the sensor without an appreciable angular deviation. In this case, only the offset needs to be corrected (see step 4 opposite).

2.4.2 Adjusting the laser beam

1. With the lens covered, let the laser beam strike the centre of the sensALIGN sensor dust cap.
2. Slide the dust cap to open the lens. Observe the four laser beam adjustment LEDs while adjusting the laser beam using the vertical and horizontal beam positioning thumbwheels. The thumbwheels are used to adjust both the horizontal and vertical laser beam angles.
3. Carry out this adjustment until all four LEDs are blinking green once every second.
4. If the LEDs are blinking green twice every second, the angle at which the laser beam enters the sensor is correct, but an offset is present. Eliminate the offset by sliding back the sensALIGN sensor dust cap to cover the lens, then loosen the chain type bracket supporting sensALIGN sensor and move the sensor sideways. At the same time, release the sensALIGN sensor clamping levers and move the sensor upwards and downwards until the laser beam is centred on the dust cap. During this adjustment, DO NOT touch sensALIGN laser.
5. Open the lens by sliding the dust cap and check the blinking of the four LEDs. If all four are blinking green once every second, then the laser beam has been correctly centred.

2.5 Handling precautions

ROTALIGN Ultra iS Shaft system and its related components which include ROTALIGN Ultra iS computer ALI 4.202, sensALIGN sensor ALI 4.900 and sensALIGN laser ALI 4.910, are precision instruments and should not be dropped or subject to physical shock.

2.5.1 Storage

Use the ROTALIGN Ultra iS Shaft case ALI 4.820 to transport ROTALIGN Ultra iS Shaft system and its related components. If the system is not used for an extended period, remove the related batteries from the components and store the components in a cool, dry and well-ventilated location.

Observe the storage temperatures and humidity specified in the technical data.



CAUTION

2.5.2 Care

All optical surfaces (sensALIGN laser aperture, sensALIGN sensor lens) must be kept clean. Use the supplied lens cleaning cloth ALI 2.905. Avoid vigorous polishing to preserve the anti-reflective coatings of the glass elements. ROTALIGN Ultra iS computer housing may be wiped clean using a soft cloth dampened with a mild, non-abrasive detergent. The display should be cleaned using a soft dry cloth.

2.5.3 Maintenance

Although the ROTALIGN Ultra iS Shaft system is essentially maintenance-free, the following points should be observed:

- › The calibration accuracy of the system components should be checked every two years as indicated by the coloured label (shown at right) affixed to the bottom of both sensALIGN laser and sensALIGN sensor housings.
- › Please return the system components to your authorized PRÜFTECHNIK service centre for calibration checking by the date indicated.

When returning battery operated ROTALIGN Ultra iS Shaft components to PRÜFTECHNIK for calibration, service or repair, ensure that the batteries are not defective. If you suspect a defect in the battery, DO NOT ship the unit with the defect battery back to PRÜFTECHNIK. You may contact your local representative for further information.



In the example above the calibration due date is November 2016



CAUTION

2.5.4 Disposal

Any waste electrical and electronics parts of the ROTALIGN Ultra iS Shaft system including memory sticks must be disposed of according to applicable safety and environmental regulations.

Customers in member states of the European Union must adhere to the EU directive 2002/96/EC on waste electrical and electronic equipment (WEEE). PRÜFTECHNIK products that fall under this directive are marked with the shown crossed-out wheeled bin symbol and must be disposed of according to this directive.

- › The marked components must be disposed of with PRÜFTECHNIK or their authorized disposal partners.
- › Such parts must be taken to the nearest collection facility.
- › If you have any questions regarding the WEEE Directive, please contact your local PRÜFTECHNIK sales representative.



2.5.5 Transporting magnetic brackets and other magnetic components

To ensure that stray magnetic fields do not affect the avionics in aircraft, the aviation industry has put forward stringent regulations for air transportation of magnetic material. The magnetic field strength of such components must not exceed specified limits. To comply with this regulation, a cover plate has been developed for all PRÜFTECHNIK Alignment magnetic brackets and components that lowers the magnetic field strength significantly, keeping it well below the required limits and therefore causing no restrictions for air transportation. The relevant safety data sheets are available for download and reference on the PRÜFTECHNIK website at www.pruftechnik.com.

2.5.6 Attachments

Any amendments to the issued certificate will be posted on the official PRÜFTECHNIK website – www.pruftechnik.com. Please visit the website on a regular basis for information on new and current products.



Note

Chapter 3: Getting started with the ROTALIGN Ultra iS Shaft system

The ROTALIGN Ultra iS Shaft system is used for any shaft alignment application, regardless of complexity. This intelligent System [iS] detects and displays any operator error, eliminates the effects of unwanted external influences such as machine vibration, while producing precise and repeatable measurements.

3.1 ROTALIGN Ultra iS Shaft system composition

The system comprises:

- ▶ The proven ROTALIGN Ultra iS computer which is the core of the ROTALIGN Ultra measurement platform.
- ▶ The intelligent sensALIGN sensor that uses intelliSWEEP – a high definition measurement mode that actively assists the user by automatically detecting and eliminating error influences such as coupling backlash, rotational angle and vibration.
- ▶ The intelligent sensALIGN laser that relays the rotational angle in which the component is located as well as its battery status.
- ▶ Other shaft alignment components such as brackets and other accessories

In addition to the shaft alignment application, the ROTALIGN Ultra measurement platform also includes bore alignment, flatness and straightness measurement, hydro power application and other geometric applications.

3.2 Obtaining alignment readings in quick intelligent steps

3.2.1 Mount components on machine train to be measured

Both sensALIGN sensor and laser are mounted on the shafts of the machine train to be measured using the supplied compact chain-type brackets. The sensor and laser are fixed to the support posts by locking the yellow clamping levers. [Refer to section 4.5 for details on mounting components.]

3.2.2 Switch on both sensALIGN sensor and laser

Both sensALIGN sensor and laser are switched on by pressing their respective On/Off push button switches.

3.2.3 Centre laser beam

The laser beam is centred on the sensor detector planes using the yellow position thumbwheels and moving sensALIGN sensor vertically along the support posts or horizontally by loosening the chain-type bracket. [Refer to sections 2.4.2 and 4.11.]

3.2.4 Press to switch on the ROTALIGN Ultra iS computer

Press and hold  the 'On/Off/Enter' key briefly. The opening screen appears.



The navigation keys are used to access available applications and options. The navigation direction is either upwards/downwards or sideways.

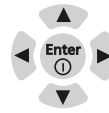

Use the navigation keys and highlight the 'Shaft Alignment' application icon in the opening "Program Manager" screen, then press  to confirm selection.

3.2.5 Enter machine dimensions

The machine set-up screen is accessed by pressing . You may use the global menu (see section 3.2.9) items 'Configuration' -> 'Units' to set the desired measurement units. [Refer to section 4.7 for details on how to enter machine dimensions.]

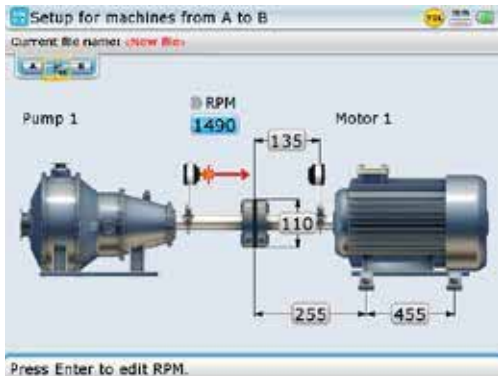

3.2.6 Start measurement

Access the measurement screen by pressing . Ensure laser beam dot is centred on the square target then rotate shafts. [Refer to section 4.11 for details on taking measurements.]

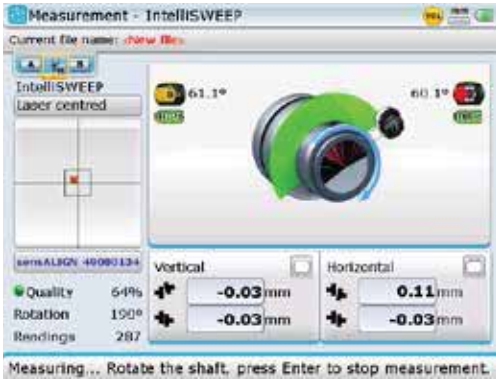

The measurement mode used in this example is IntelliSWEEP. Other measurement modes are described in section 5.1.

3.2.7 View alignment results

After measurement, press  to view the alignment results.

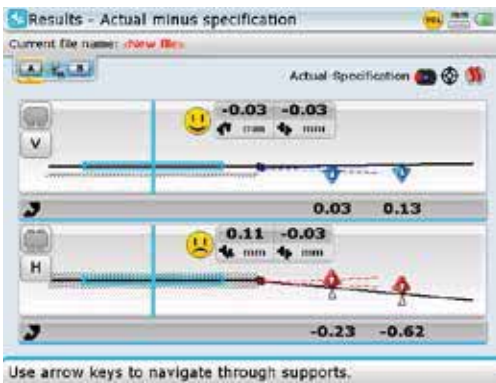

3.2.8 Context menu items

A useful feature available in ROTALIGN Ultra iS computer is the availability of display screen related context menu items for each individual screen. Useful menu items that include accessing the program manager, turning the computer off and configuring the instrument can be accessed via the context menu that appears when  is pressed at any time.

The context menu items are accessed using the navigation keys. The navigation direction is either upwards/downwards or sideways. Alternatively, use may be made of the data entry keys which provide navigation shortcuts.

All context menu items are labelled with digits for quick access. The required menu item is accessed directly by pressing the corresponding data entry key.

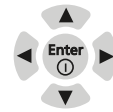

Note

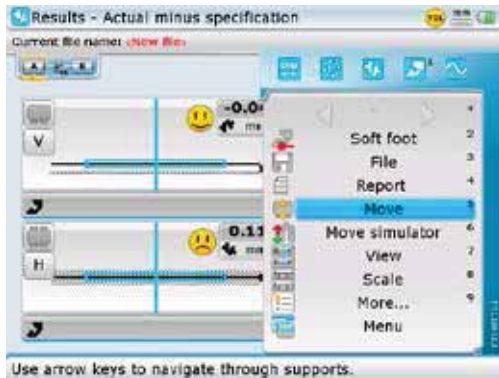

Use arrow keys to navigate through supports.

Context menu items are available for every screen. In this example, the context menu items available from the “Results – Actual minus specification” screen are displayed.



Invokes global menu.

Context menu items are available from the program manager screen

The item ‘Menu’ is used to access the global menu, which may also be accessed directly by pressing the corresponding data entry key .

3.2.9 Global menu

The ROTALIGN Ultra iS computer uses a global menu concept to shorten the steps to reach any required menu item. The global menu appears in the following two forms.

- › a configuration global menu that appears within the program manager
- › a complete global menu covering all menu items – this appears within the Shaft application

The global menu may be accessed at any time by pressing  twice.

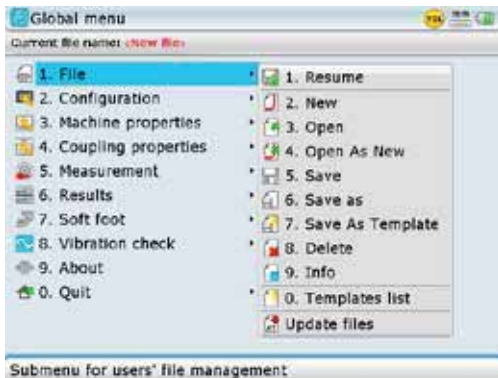

Global menu when accessed within the Shaft application









The configuration global menu accessed from the program manager screen

3.3 Tips and tricks

3.3.1 Program manager

- ▶ While in the program manager, the data entry keys are used to select the corresponding application icon in a numerically ascending order. This is possible only up to the tenth icon.

3.3.2 General

- ▶ Pressing  twice opens the global menu.
- ▶ Pressing  long enough also opens the global menu.
- ▶ Pressing  for approximately 3 seconds prompts the 'turn off system' dialog.
- ▶ Pressing  for approximately 7 seconds resets the system.
- ▶ For machine trains with more than one coupling position, pressing either  or  long enough moves the view of the train to the left or right respectively.

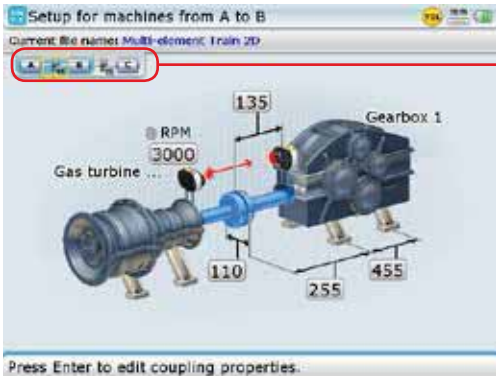



The displayed view shows machines A and B with the cursor on coupling 1

32

- ▶ Pressing the corresponding data entry key moves the view to the respective coupling position (observe inset in display).



The displayed view shows machines B and C with cursor on coupling 2. The view is prompted from the previous screen by pressing either  or  or  long enough.

- ▶ Pressing either \leftarrow or \rightarrow moves the view of the train to the right or left respectively.

3.3.3 Dimensions (set-up)

- ▶ When in set-up and units are set to Imperial system, entering a dimension as 11.3.8 corresponds to 11 3/8 in.



- ▶ Pressing CLR while in set-up prompts the deletion of the selected machine.
- ▶ When selecting type of machine the orientation of the machine can be altered by pressing either \leftarrow or \rightarrow .
- ▶ Pressing DIM twice while in set-up zooms the machine train out and in again.
- ▶ When entering file or element names, pressing \leftarrow cycles through the characters that can be entered. The characters are capital letters (upper case), small letters (lower case) and numerals. With numerals selected, pressing π long enough enters the value π .
- ▶ Pressing Δ or ∇ zooms out or zooms in the machine image respectively. Note that any one of the train elements has to be highlighted for the zoom function to respond.

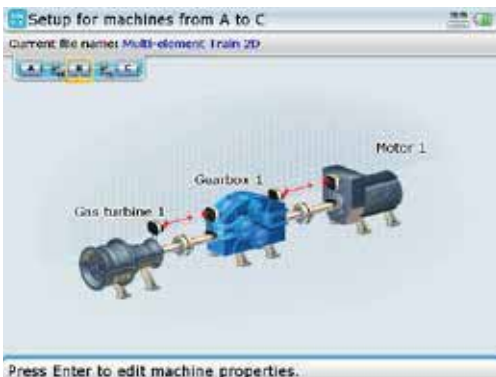

3.3.4 Measurement

- ▶ Pressing  twice activates auto measurement.





In auto measurement any of the three measurement modes – IntelliSWEEP, Multipoint or Static measurement is started directly by the appropriate action.

- ▶ IntelliSWEEP mode is activated by rotating the shafts
- ▶ Multipoint is started by pressing 
- ▶ Static measurement is started by pressing either the data entry keys or any of the navigation keys



Note

3.3.5 Results

- ▶ Pressing  or  while in results, cycles the results between vertical (V), horizontal (H) and both H&V.
- ▶ Pressing  or  long enough zooms out or zooms in the results image respectively.

Chapter 4: Shaft alignment application

4.1 Starting the shaft alignment application

Before the application can be started, a licence code must be entered in the licence manager. In most cases the application is licenced at the factory and the system is delivered with the Advanced Shaft firmware registration certificate ALI 4.741 which contains the entered licence code.



Note

4.1.1 Starting the licence manager

After switching ROTALIGN Ultra on, use the navigation keys to highlight 'Configuration' icon.

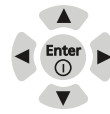



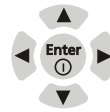

Press  to access this option, then use the navigation keys to highlight the 'Licence Manager' icon.



35



With the icon highlighted, press  to access the “Licence Manager” screen. Use / to highlight ‘Shaft Alignment’, then press  to proceed with entering the application licence code (registration key) in the editing box. After successful registration, a green check mark appears next to the application, and the application level appears as a suffix to the firmware version.



The three application levels available are ‘Standard’, ‘Advanced’ and ‘Expert’ The registered level will appear as a suffix to the firmware version.

The application shaft alignment can now be started. Please refer to section 6.5 for a brief description on upgrading from the Standard Shaft application level to the Advanced Shaft level.

4.2 Horizontal machine alignment - preparing for the alignment procedure

36 Before using the Shaft Alignment application, prepare the machines as described below.

Switch off the machines before commencing work, and make sure that they cannot be started accidentally!



4.2.1 Solid, flat foundation

A solid, rigid foundation is required to obtain correct, lasting shaft alignment that allows long-term uninterrupted machine service.

4.2.2 Machine mobility

If the machine to be moved stands directly on the foundations, it cannot be lowered for alignment correction. It is therefore advisable to start with about 2 mm (80 mils) of shims beneath the feet of both machines. Hydraulic or screw-type positioning aids are recommended for horizontal movement.

4.2.3 Rigid couplings

Rigid couplings must be loosened before measurement so that they do not distort the alignment condition.

4.2.4 Shaft play and coupling backlash

Axial shaft play is detected and compensated for in alignment results (but affects machine operation).

4.2.5 Soft foot

Soft foot causes the machine frame distortion every time the bolts are loosened or tightened, making proper alignment difficult or impossible.

4.2.6 Thermal growth, alignment targets, tolerances

These values can be obtained from the individual machine specifications, and then entered into the program. In addition, a built in thermal growth calculator can help you derive these values from the observed changes in temperature.

4.2.7 Measurement separation

As the system requires no mechanical connections (such as cantilevered dial indicator brackets) to span over the coupling during measurement, alignment may easily be performed over large laser – sensor separations.

Note that over very large distances the shafts and coupling may sag, and the machines may need to be aligned to take this into account. Refer to the machine manufacturer's specifications.

4.3 Check soft foot

Refer to section 5.5 for soft foot.

4.4 Mount the brackets

Mount the brackets on either side of the coupling on either the shafts or on the solid coupling hubs, and both at the same rotational position.

Please note the following in order to obtain the highest possible measurement accuracy and to avoid damage to equipment:

- ▶ Ensure that the brackets fit solidly onto their mounting surfaces!
- ▶ Do not use self-constructed mounting brackets, or modify the original bracket configuration supplied by PRÜFTECHNIK Alignment (for example, do not use support posts longer than those supplied with the bracket).



4.4.1 Bracket mounting procedure

To fit the compact chain brackets, refer to the diagram shown below and follow the instructions carefully.

1. Choose the shortest support posts which will still allow the laser beam to pass over or through the coupling. Insert the support posts into the bracket.
2. Fasten them in place by tightening the hex screws on the sides of the bracket frame.
3. Place the bracket on the shaft or coupling, wrap the chain around the shaft and feed it through the other side of the bracket: if the shaft is smaller than the width of the bracket frame, insert the chain from the inside of the bracket as shown in the diagram; if the shaft is larger than the bracket width, insert the chain into the frame from the outside.
4. Catch the chain loosely on the anchor peg.
5. Turn the bracket thumbscrew to tighten the assembly onto the shaft.
6. Clip the loose end of the chain back onto itself.

The bracket should now be tight upon the shaft. Do not push or pull on the bracket to check, since this could loosen its mounting.

To remove the brackets, loosen the thumbscrew, then remove the chain from its anchor peg.

The compact chain-type brackets cover most situations, but in cramped or special cases, other types of brackets may be required. Ask your PRÜFTECHNIK representative for details.



Note

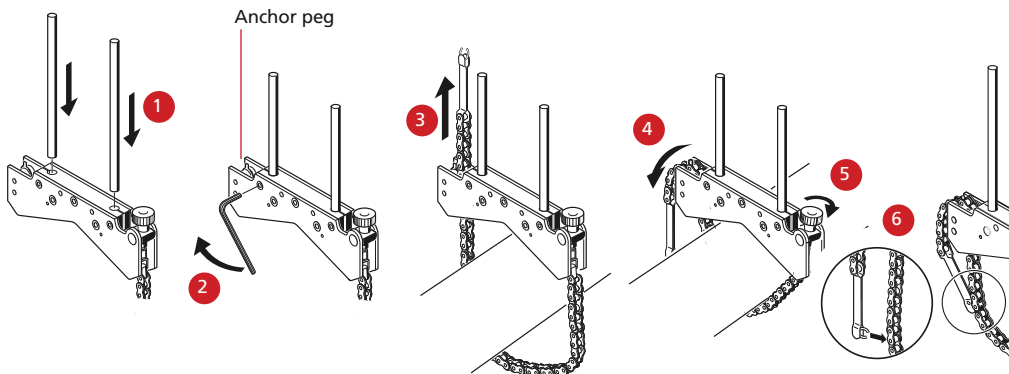

4.5 Mount sensALIGN laser and sensor

Mount sensALIGN laser on the support posts of the bracket fixed on the shaft of the left machine (usually reference machine), and sensALIGN sensor on the support posts of the bracket fixed on the shaft of the right machine (usually moveable machine) – as viewed from normal working position. Before mounting both sensALIGN laser and sensor, make sure that the yellow clamping levers are in the open position by placing them to the front. This enables components to slide onto the support posts.

Fix both sensALIGN laser and sensor onto the respective support posts by locking the yellow clamping levers. Lock the levers by pushing them backwards until they rest on the stoppers. Ensure that the laser can pass over or through the coupling and is not blocked.

Both sensALIGN laser and sensor should be at the same height, as low as possible, yet just high enough for the beam to clear the coupling flange. They should also visually appear to be rotationally aligned to each other.

Make the final adjustments, loosening the brackets slightly if necessary, then rotating them and retightening.

Clamping levers in the open position

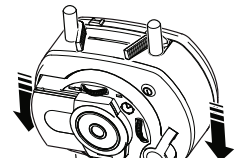
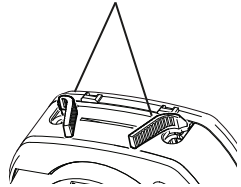

Clamping levers in the open position allows sensALIGN laser or sensor to slide onto the support posts.

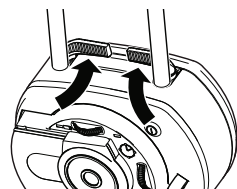
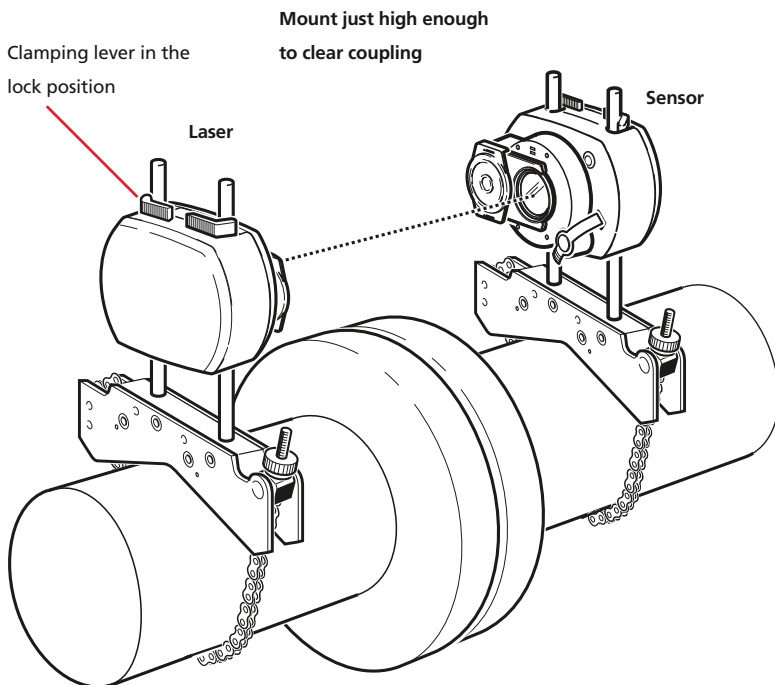

Locking the clamping levers by pushing them against the stoppers fixes sensALIGN laser or sensor onto the support posts.

4.6 Switch ROTALIGN Ultra iS on and start application

Press  and hold for a few seconds. The four laser adjustment and alignment condition LEDs light up. Shortly afterwards, the splash screen appears, followed by the program manager screen below.



Use the navigation keys to highlight 'Shaft Alignment'. Press  to access the application. The opening template in the set-up screen below appears.

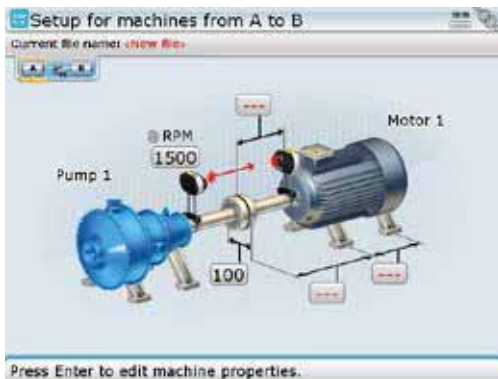
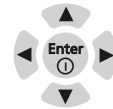

If desired, elements in the machine train can be displayed in 2-D format using the dimensions screen context menu item 'Switch to 2D mode'. One may revert to the 3-D format using the corresponding 'Switch to 3D mode' context menu item. Both formats will be used in this handbook.

The above screen will appear only if the customization option 'Resume policy' has been set to 'Resume files manually'. (See customization - described in section 8.1.10)



Note

4.7 Enter machine dimensions

Machine information and dimensions are entered using the grey data entry keys. The required missing dimensions are entered directly. Use the navigation keys to highlight the dimension box and enter dimension by pressing the appropriate data entry keys. The editing box appears as soon as the first key is pressed.

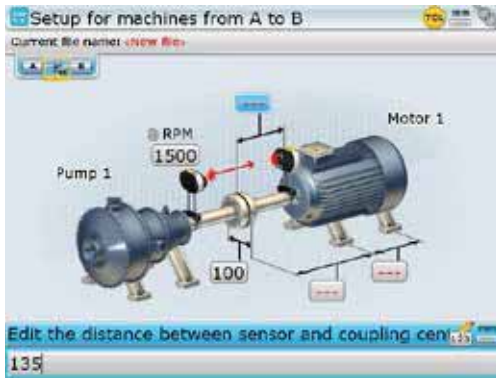

Editing box

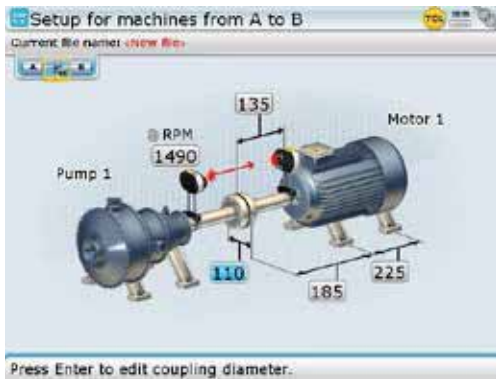

Confirm the entered value by pressing either Enter or t . The highlight springs to the next empty dimension box. If necessary, use the navigation keys to highlight the dimension to be edited.

The dimensions to be entered vary according to machine and type of coupling. In a standard horizontal alignment application enter dimensions as follows:



4.7.1 Coupling diameter

The coupling diameter can be obtained by measuring the circumference of the coupling and dividing the value by π (3.142).

The default value is 100 mm (10" if set to US units). Should there be need to edit the value, highlight the value using the navigation keys. Edit the value directly using the data entry keys. Confirm the new value by pressing either  or . The highlight springs to the next dimension box automatically.

4.7.2 Sensor to coupling center

This is the distance between the "distance marking" on top of sensALIGN sensor and the coupling center. Should there be need to edit the value, use the navigation keys to highlight it, and edit it directly using the data entry keys.

4.7.3 RPM (revolutions per minute)

The default value is 1500 (1800 if set to US units). Should there be need to edit the value, use the navigation keys to highlight it, and edit it directly using the data entry keys.

4.7.4 Coupling center to front foot, right machine

This is the distance from the coupling center to the pair of feet on the right machine nearest to the coupling.

4.7.5 Front foot to back foot, right machine

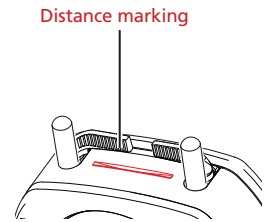





The distance marking groove is practical for attaching a tape measure lip when determining required machine train dimensions.

4.8 Machine properties

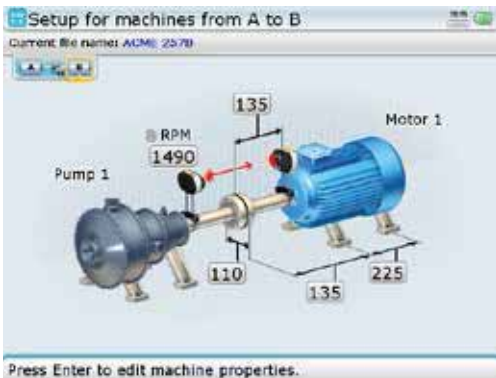
The set-up screen is used to enter machine dimensions as well as editing machine properties.

Use  /  to highlight machine to edit.



Press  to access machine properties. To select machine type, use the navigation keys to highlight the 'Type' box then press . Select type of machine from the drop down menu that appears using  / .

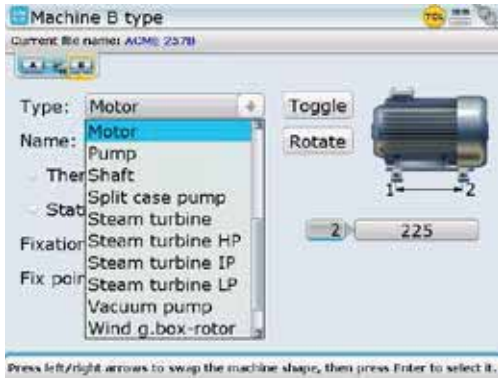



Confirm selection by pressing either  or .

The orientation of the machine may be changed using the 'Toggle' and/or 'Rotate' buttons. Use the navigation buttons to highlight either button, confirming selection by pressing . The toggle button is used change the orientation of the selected machine along the shaft axes. The rotate button is used to change the orientation of the entire machine train from horizontal to vertical orientation and vice versa.





The toggle button flips the selected train element along the shaft axes.

The rotate button changes the entire machine train orientation (from **Horizontal** to **Vertical** and vice versa).

To edit machine name, use   to place cursor on the 'Name' box then enter the machine name directly using the data entry keys. The editing box appears as soon as the first key is pressed.





Repeatedly pressing  brings you back to the set-up screen.

When entering names that contain both upper and lower case characters, as well as numerals, use  to cycle through the three options.

Press and hold down  while observing the status indicator at the bottom right corner of the screen.

This displays the character to be entered.



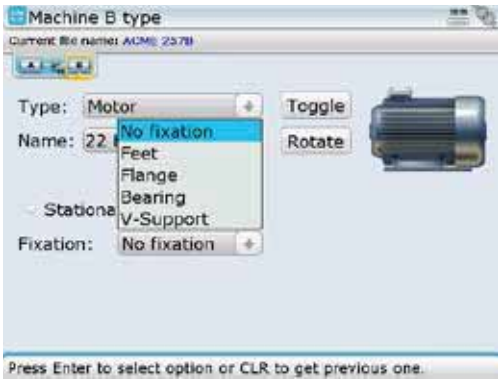

Confirm entry by pressing either  or .

To enter the type of machine mounting, use the navigation keys to place cursor on the 'Fixation' box then press . Select type of mounting from the drop down menu that appears using  / .



Note that the navigation is dependent on the scheme selected under 'Customization'. In this case we are using the default scheme.

Confirm selection by pressing either  or .



Depending on the type of mounting, either the position or number needs to be edited. If the machine is mounted on feet or bearings, the number is edited by placing cursor using  /  on the fixed points box. Press  to highlight the numeral. Edit value using  (increases values) or  (decreases value).



To check or uncheck the 'thermal growth enabled' or the 'stationary machine' box, highlight either box using the navigation key. Pressing  with the box highlighted, checks or unchecks the respective box.

Note that the above navigation depends on the scheme selected. In this particular case the default scheme is used.

Confirm value by pressing either  or .

If however the machine is flange-mounted, the position of the flange requires to be entered. To enter flange location, use the navigation keys to place cursor on the 'Location' box then press . Select location from the drop down menu that appears using  / .



Confirm selection by pressing either  or .

Thermal growth values can be entered only when the type of mounting is either machine feet or bearing or V-shaped support, and 'Thermal growth' enabled. To enter thermal growth values press **Menu** while in the "Machine type" screen. The context menu appears.

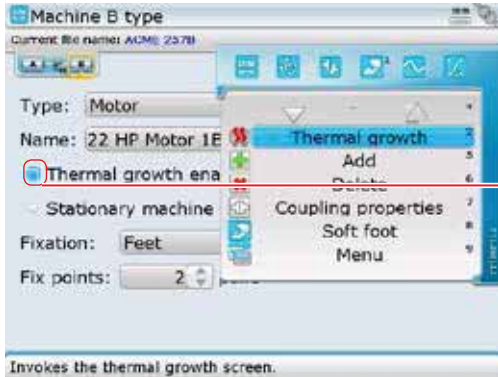

Thermal growth values are activated when the 'thermal growth enabled' box is checked.

Press **Tab** to access the thermal growth screen. Alternatively, use either **Up** / **Down** to highlight 'Thermal growth', confirming selection by pressing **Enter**.

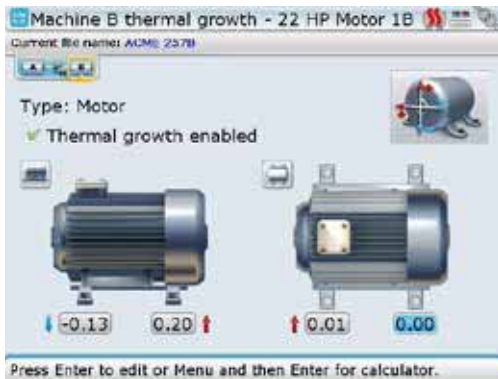





Thermal growth values may be entered directly using the data entry keys.

Use **Left** / **Right** to cycle through the feet positions, highlighting the value boxes. When a value box is highlighted, enter thermal growth value directly using the data entry keys. Confirm entry by pressing either **Enter** or **T**.

4.9 Coupling properties

Coupling properties are entered and edited in the same manner as for machine properties.

Use the navigation keys to place cursor on the 'Type' or 'Format' box then press . Select type of coupling or result format from the drop down menu that appears using  / .

Use the navigation keys to highlight the 'targets enabled' or 'tolerances enabled' check box. With either box highlighted, press  to check or uncheck the respective box.

Targets and tolerances are activated only when the respective box is checked.



Note that the navigation is dependent on the option selected in 'Customization'.



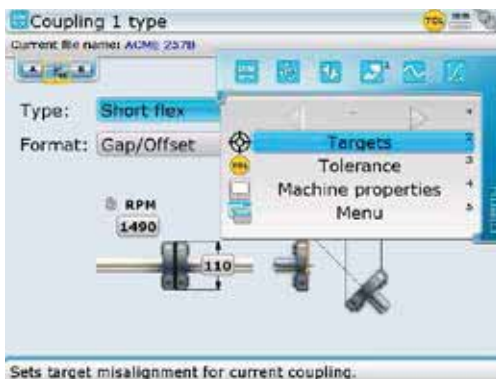

To enter coupling target values, press  while in the "Coupling type" screen. The context menu appears. Use either  or  to highlight 'Targets'.



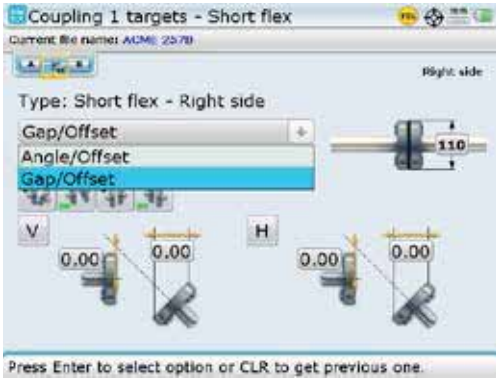

The coupling targets screen may alternatively be accessed directly from the context menu by pressing the corresponding data entry key.

Press  to confirm selection. The coupling targets screen that follows appears.



With the 'Type' box highlighted, pressing  reveals a drop down menu with the available coupling targets formats. Select required format using either  or , confirming selection by pressing either  or .

Use the navigation keys to cycle through the coupling properties. To enter coupling target value, highlight the value box using the navigation keys. With the value box highlighted, enter target value directly using the data entry keys. Press  or  to confirm entry.

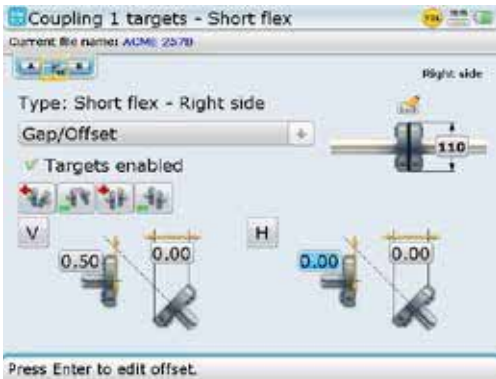

Pressing  while in “Coupling targets” screen reveals the context menu shown below.



The displayed context menu items can be accessed directly by pressing the corresponding data entry key.

The displayed menu items perform the following functions:

- › Reset all values – used to clear all entered coupling target values and to reset coupling format and dimension back to those used in the “Set-up” screen
- › Recalculate targets – used to set coupling target values to correspond to the coupling diameter used in the “Set-up” screen
- › Sign convention – displays the definition and graphic depiction of sign convention
- › Left/Right/Both – used to select the direction considered when analyzing coupling targets. If the option “Both” is selected, coupling target values cannot be edited
- › Dial gauge values – used to enter coupling target values as dial indicator readings
- › Thermal growth – used to access the machine thermal growth screen

The context menu to the coupling type screen discussed previously has in addition to the menu item 'Targets', also 'Tolerance' and 'Machine properties'.



Press **3def** to display the system tolerance table. Alternatively, highlight 'Tolerance' using **Δ** / **▽** and confirm selection by pressing **Enter**. The menu item 'Machine properties' is used to access the machine properties dialog screen.

The menu item 'Tolerance' is used to display the system tolerance table.

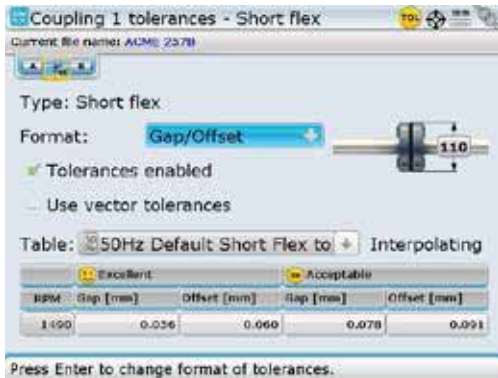

The displayed tolerance values are coupling format, frequency and rpm dependent. These parameters may be selected from the two drop down menus and the rpm edited directly.

Note: The item 'User vector tolerances' is not available in the standard level.

50

Pressing **Menu** while in 'Coupling tolerances' reveals the context menu shown below.

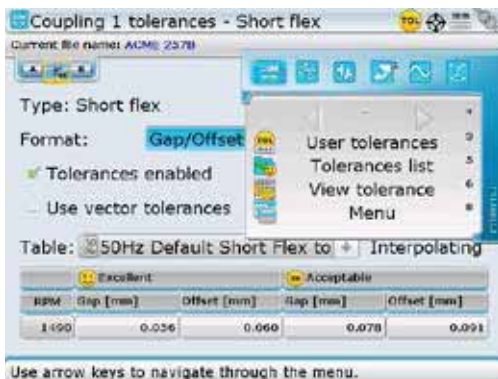

The displayed menu items perform the following functions:

- › Tolerances list – used to display types of couplings and rpm frequencies available in the tolerance table
- › View tolerance – displays the coupling tolerance details
- › Max values – used to specify individual tolerances

Use the context menu item 'Max values' to access the coupling tolerance screen used to enter maximum tolerance values.



Use the navigation keys to highlight the 'Format' box. Access the drop down menu by pressing Enter . Use Δ / ∇ to highlight the required format, confirming selection by pressing Enter or t . Using the navigation keys proceed to highlight the respective value box and enter maximum tolerance values with the data entry keys directly. The values entered above are independent of rpm. When these values are enabled, they override the system tolerance table.

After machine and coupling properties have been entered, use t to return to the set-up screen.

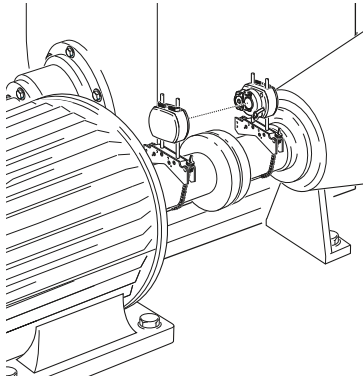

4.10 Flipping machines

If machines are mounted such that access to the opposite side of the machines is restricted, and there is need to designate the right machine as stationary, then the flip function is used.



In this example, the machine combination has been mounted next to a wall, and the right machine is the stationary machine. As the opening template in the Shaft application set-up screen shows the stationary machine on the left, the flip function is used to designate the right side machine as stationary.

Situations where the machine positions on screen require rearranging often occur when using predefined machine templates or during set-up (as can be seen in the illustration above).

1. Press  while in the "Set-up" screen, then use  /  to highlight the context menu item 'Flip machines'.



Alternatively, press  to open the "Flip machines" hint screen.

Note that once measurement has been taken, the "Set-up" screen context menu item 'Flip machines' disappears and the machine positions may not be switched around again.

2. Press  to confirm selection. A "Flip machines" hint screen appears.

The hint reminds the user that the laser must always be mounted on the left machine as viewed by the user and sensor to coupling center distance must be checked again.

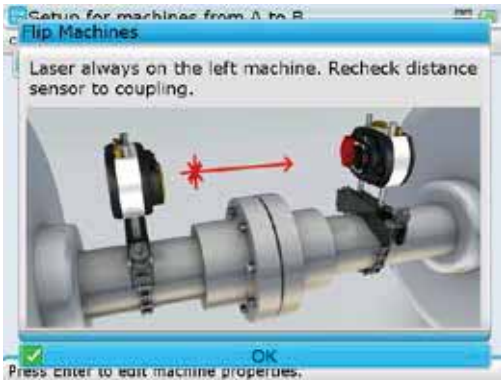

3. Press  or  to confirm flipping machines.

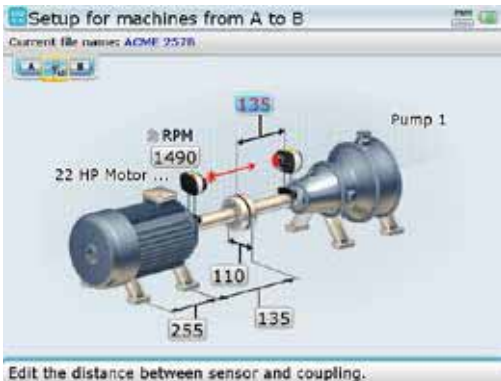

The pump which is the stationary machine has now been flipped to the right hand side but still remains the stationary machine.

4. Ensure the laser is mounted on the machine on the left, then check the distance between the sensor to coupling center.

4.11 Laser beam adjustment

After entering all dimensions, proceed to adjust the laser beam such that it strikes the sensALIGN sensor lens perpendicular to the lens surface.

1. Slide the sensALIGN laser dust cap to expose the aperture.

sensALIGN laser MUST remain off.

2. With the laser OFF, carry out a preadjustment to ensure that the laser beam will be emitted perpendicular to the laser housing. Use the two yellow beam position thumbwheels to centre the 'bulls-eye' as accurately as possible.
3. Press the ON/OFF push button switch to turn sensALIGN laser on.

Do not stare into the laser beam!

4. If both sensALIGN laser and sensor have been positioned at the same height and roughly the same angular position during mounting (see section 4.5 – "Mount sensALIGN laser and sensor"), the laser beam should strike the sensor dust cap.
5. Slide the sensALIGN sensor dust cap to open the sensor lens and observe the four sensALIGN sensor laser beam adjustment LEDs. If all four LEDs are blinking green once every second, then the laser beam is correctly centered on the sensor, and you may proceed with measurement (section 4.11).
6. If however, the laser beam is still not correctly centered, readjust the laser beam using the yellow vertical and horizontal positioning thumbwheels. Observe the four laser beam adjustment LEDs while adjusting the thumbwheels.
7. If all four LEDs are blinking green TWICE every second, the angle at which the laser beam enters the lens is correct, but an offset is present. To eliminate the offset, slide the sensALIGN sensor dust cap to cover the lens, then (if necessary) loosen the chain type bracket supporting sensALIGN sensor and move the sensor sideways. At the same time, if necessary, release the sensALIGN sensor clamping levers and move the sensor upwards and downwards until the laser beam is centred on the dust cap.

During this adjustment, DO NOT touch sensALIGN laser.

8. Open the sensor lens by sliding the dust cap and check the blinking of the four LEDs. If all four are blinking green once every second, then the laser beam has been correctly centred and measurement may proceed.



WARNING



WARNING

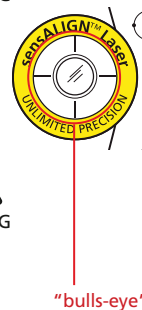

Note

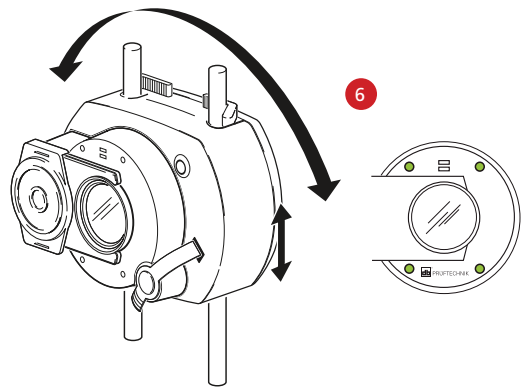
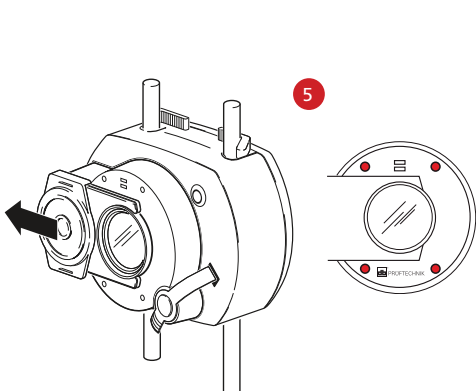
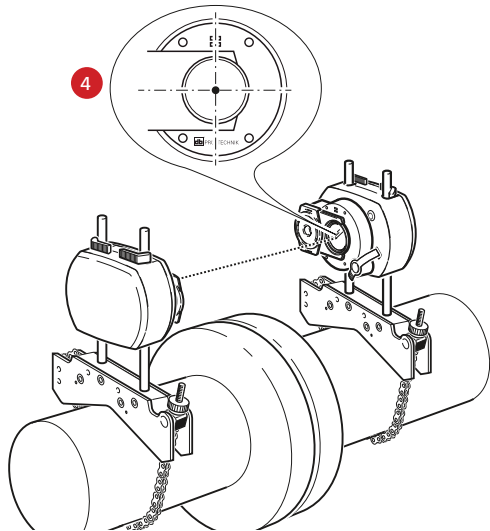
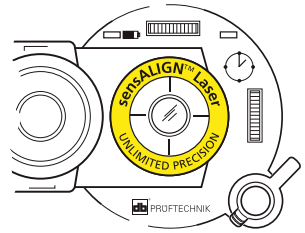
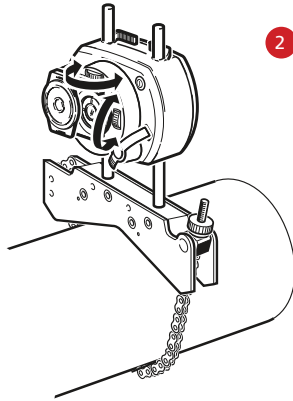
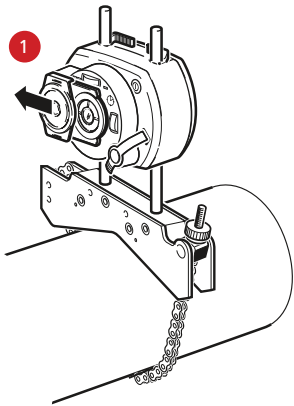



4.12 Taking measurements

With all four sensALIGN laser beam adjustment LED blinking green once every second – an indication that the laser beam has been correctly adjusted – press to open the measurement screen. As sensALIGN sensor has not yet been initialized, the ‘Sensor error’ message will appear on the screen. Press then use / to highlight the context menu item ‘Sensor selection’.

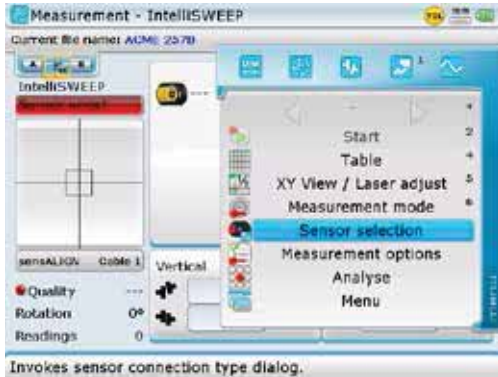

Invokes sensor connection type dialog.

Confirm selection by pressing . The sensor selection window opens.

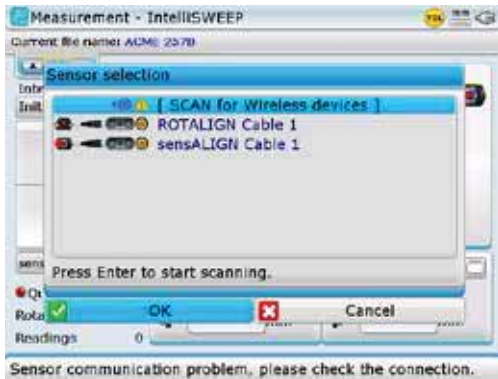



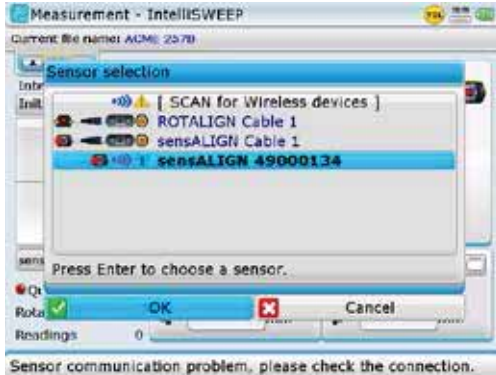

The sensor selection window may also be used to select the sensALIGN sensor and laser cable ALI 4.921-2 to transmit data between ROTALIGN Ultra iS computer and sensALIGN sensor. This emergency alternative is described in section 4.12a.

Use / to highlight ‘Scan for wireless devices’, then press to confirm selection. With this step, the neighbourhood is scanned for Bluetooth devices.

After the scanning process is completed, any Bluetooth devices detected will be listed on the screen.



sensALIGN sensors that have been detected are stored in the system and always appear in the sensor selection screen. Sensors may be deleted from the displayed list by pressing  with the sensor highlighted.

Use   to select the appropriate sensALIGN sensor (e.g. 'sensALIGN 49000134'). Press  to confirm selection and proceed with measurement. When sensALIGN sensor is initialized, and the laser beam is not centered, use the laser adjustment pop-up wizard to correctly adjust the laser beam.



It is recommended to adjust the laser beam until the 'Laser centred' message appears in the laser beam adjustment pane.

The laser adjustment pop-up wizard is the primary laser beam adjustment feature in the Shaft application. Other available features include:

1. Visual display of any angular error in the incident beam
2. XY view
3. Intelli laser position
4. Half function

These features are described in section 5.2 'Measurement options'.



Before proceeding with rotating shafts, ensure that the 'Laser centered' message (1) appears on the adjustment pane.

The standard measurement mode is the Continuous Sweep mode. [IntelliSWEEP mode is the standard measurement mode in both Advanced and Expert Shaft levels.] Measurement may be started automatically when the shafts are rotated or triggered manually using the  key. The preferred preference may be set under the "Measurement options" screen which may be accessed via the global menu or the "Measurement screen" context menu item 'Measurement options'.

Other measurement modes are available. The table below gives a guide as to which measurement mode is ideal for which measurement. In this section we describe the Continuous Sweep. Details on the other modes can be found in section 5.1 'Measurement modes'.

Application	Measurement mode Standard Shaft	Measurement mode Advanced/Expert Shaft
Standard machines	Continuous Sweep	IntelliSWEEP
Nonrotatable shafts, sleeve bearings, white metal bearings, journal (radial) bearings, shafts that are hard to turn, shafts with herky-jerky rotation, situations with long spans or severe misalignment that will readily cause the beam to fall out of range	Multipoint measurement	Multipoint measurement
Vertical machines (four feet or flange mounted)	Static measurement	Static measurement
Uncoupled shafts	Static measurement/ Multipoint measurement	IntelliPOINT/ IntelliPASS
Verifying measurements taken using dial indicators	Dial gauge	Dial gauge

Rotate the shafts a full turn, or as far as possible.



Measurement quality is an intelligent feature based on several measurement and environmental criteria. The resulting quality is depicted using the following colour codes:



- — excellent
- — good
- — acceptable
- — poor

If the intelligent features are switched off, the measurement standard deviation (SD) will be displayed if selected under the measurement screen context menu item 'Measurement options'.

Press  to finish measurement and collect data in order to display results. The following screen appears.



The hint appears only if the customization option 'Workflow' is enabled. The option is selected via 'Configuration' -> 'Customization'.

Highlighting 'Yes' using  /  and confirming selection by pressing , displays feet and coupling results.

Note that the coupling values presently displayed are real-time values.

Alternatively, the coupling results may be displayed after shaft rotation by pressing  and highlighting the menu item 'Stop' from the context menu that appears.

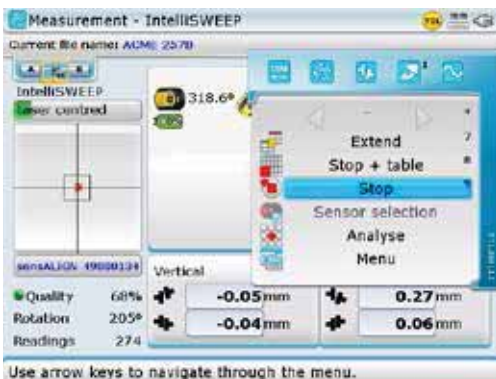

4.12a Taking measurements using the sensALIGN sensor and laser cable

If necessary, measurement data from sensALIGN sensor may be transferred to ROTALIGN Ultra iS computer using the sensALIGN sensor and laser cable ALI 4.921-2. Such cases may arise due to low sensor battery capacity or when measurement is carried out with the sensor rechargeable battery dismantled.

1. Insert the quick fit straight-ended sensALIGN sensor and laser cable plug into the eight-pin sensor socket on the top of ROTALIGN Ultra iS computer housing with the red dot at the front.

Match the double-sided arrow head on the plug to the red marking on the socket to ensure proper plug orientation; otherwise the pins inside the plug may be damaged.

To disconnect, grasp the ribbed collar of the plug on the sensALIGN sensor and laser cable (ALI 4.921-2) and carefully pull it out of the ROTALIGN Ultra iS computer sensor socket.

2. Insert the right-angle connector on the sensALIGN sensor and laser cable ALI 4.921-2 into the sensALIGN sensor "charger/adaptor/cable" socket.

Insert the connector such that the red dot on the connector matches the red marking on the sensALIGN sensor socket to ensure proper plug orientation; otherwise the pins inside the connector may be damaged.

To disconnect, grasp the ribbed collar of the right-angled connector and carefully pull it out of the sensALIGN sensor "charger/adaptor/cable" socket.

Note that sensALIGN laser may also be powered through the ROTALIGN Ultra iS computer using the sensor/laser cable ALI 4.921-2. Connection between ROTALIGN Ultra iS computer and laser is similar to the sensor connection described on the main column.



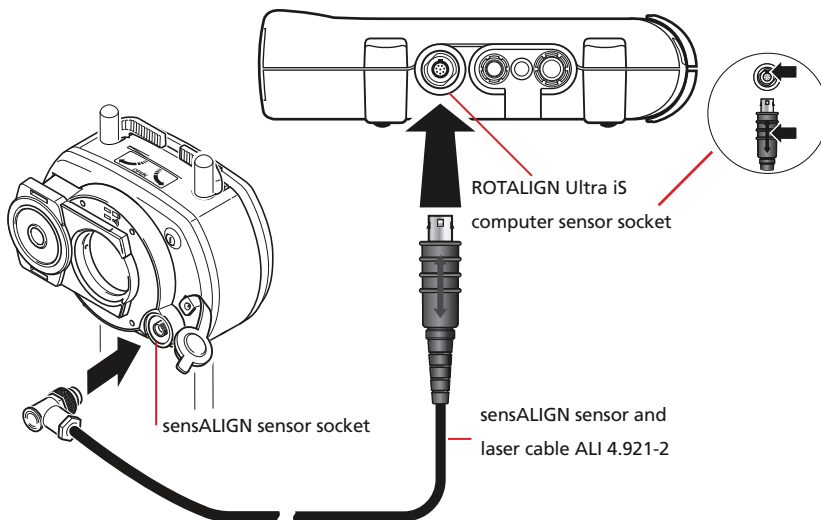

If sensALIGN sensor rechargeable battery capacity is low, connecting the sensALIGN charger/adaptor during measurement cuts off the sensor measurement mode. Measurement may be resumed only by pressing the sensor 'On/Off' push button briefly. Refer to the appendix for the sensor/laser 'on/off/charge' workflow.



- Use the “Measurement screen” context menu item ‘Sensor selection’ to set the mode in which measurement data is transferred from sensALIGN sensor to ROTALIGN Ultra iS computer.



- Use / to highlight ‘sensALIGN cable 1’ then press  to confirm selection. sensALIGN sensor will be initialized and measurement using the sensALIGN sensor and laser cable ALI 4.921-2 may proceed.

4.13 Results

Once measurement is completed, press  to view alignment results. ROTALIGN Ultra iS intelligent features guide the user to obtain reliable alignment results.

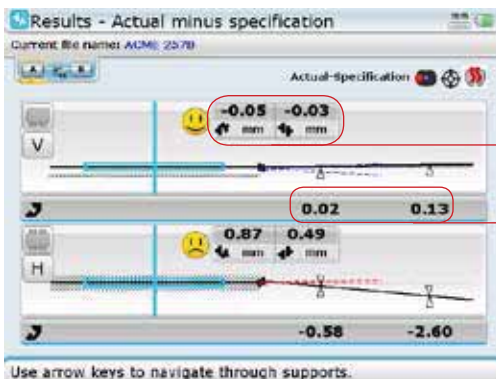

In this example, the left machine was defined during set-up as static.

Coupling values

Feet position

The above display shows the measured alignment condition along with numerical values for the actual machine feet positions.

With ROTALIGN Ultra iS, any one pair of feet can be designated as static.



Note

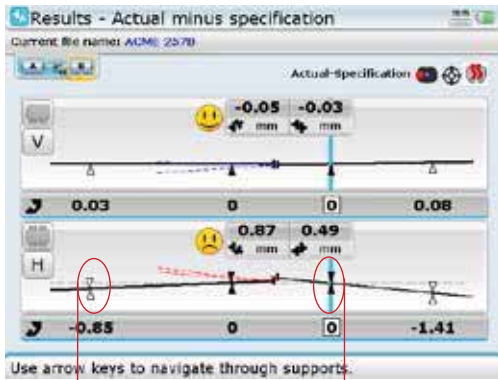

Unfixed feet pair

Static feet pair

To designate any pair of feet fixed, place the blue vertical cursor line on the feet pair using \leftarrow / \rightarrow . Press Enter to fix the selected pair of feet. The feet position is highlighted black. To unfix any pair of feet, place the cursor line on the static pair of feet pair using \leftarrow / \rightarrow , then press Enter .

Note that machine feet are displayed in the results screen only when the 'Stationary machine' box is checked in the "Machine type" screen.

4.13.1 Results screen context menu items

The context menu shown below appears when Menu is pressed while in results screen.

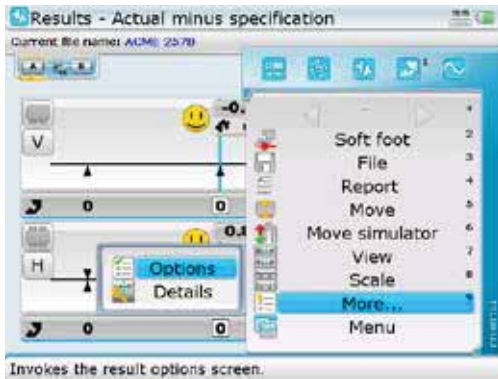

The following context menu items contain sub-menu items that are accessed using \leftarrow : 'File', 'View', 'Scale' and 'More...'.

The context menu items are scrolled using Δ / ∇ . Item selection is confirmed by pressing Enter . Alternatively, access the numbered menu items directly by pressing the corresponding data entry key.

4.13.1.1 Results options

The "Results options" screen below is accessed via the context menu item 'More...' followed by the sub-menu item 'Options'.

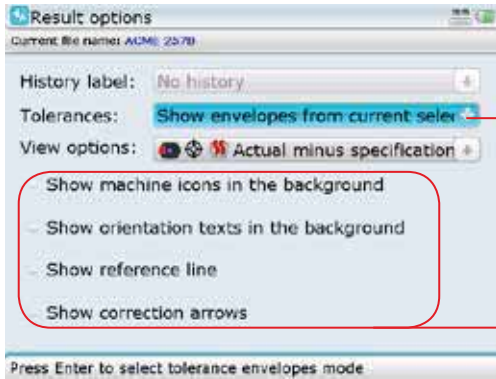

Tolerances' envelopes can be activated or deactivated from the drop down menu in this screen.

Note that these four options are related to the scaling of the machine graphics. Only one of the two options ('Show machine icons' or 'Show reference line') can be selected at any one time. When machine icons are selected, the options 'Show orientation text' and 'Show reference line' are greyed out.

The 'View options' drop down menu provides the following options:

- › 'Actual' – used to show just the measured alignment values without regard to any target values or thermal growth values that have been entered, even if they are active
- › 'Specification' – shows just the effect of any target specifications and/or thermal growth values that may have been entered and activated, without regard to any measured misalignment
- › 'Actual minus Specification' – this option considers any specified coupling targets or machine thermal growth, and is the default view. It is the option that should be used when actually performing alignment corrections

If the option 'Show correction arrows' is activated, coloured tolerance arrows appear at the feet positions as further help in determining the coupling alignment condition.

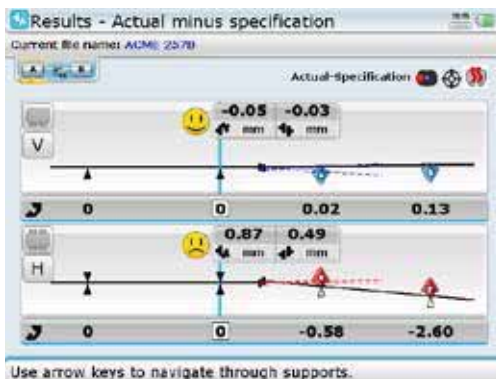

The colour codes are translated with respect to the coupling alignment condition as follows:

- Blue – excellent [foot should not be moved]
- Green – good [if possible foot should remain unaltered]
- Red – poor [foot requires moving to attain a better alignment condition]

4.13.1.2 Results details

The submenu item 'Details'/'No details' is used to display or hide results information at any highlighted machine foot pair.

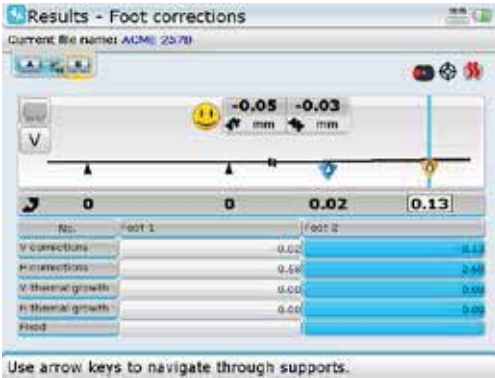

In this example, the results details of the right machine back foot pair are displayed marked blue.

If the highlighted element is a flanged machine, bolt positions and shim values are displayed.

4.13.1.3 Scale

Scaling options are provided by the context menu item 'Scale' whose sub-menu items include 'Original' – refers to scaling to size, 'Equal machine length' – both stationary and moveable machines are displayed with equal size, 'Equal fixation distance' – graphic is displayed with equal separation between the machine forward and back feet, 'All equal' – displays the graphic with identical sizes for both machine and feet positions.



4.13.1.4 View

The context menu item 'View' has four submenu items that are used to select the desired depiction.

4.13.1.5 Rotate view

The submenu item 'Rotate view' allows the user to view the machines, and subsequently perform Move corrections from either side without having to change the orientation of ROTALIGN Ultra iS computer.

This function is particularly helpful when the machines can be accessed from both sides.

'Rotate view' functionality is available within the "Results", "Move" and "Move simulator" screens.

After obtaining measurement results, press  then use the navigation keys and highlight 'View' -> 'Rotate view'.

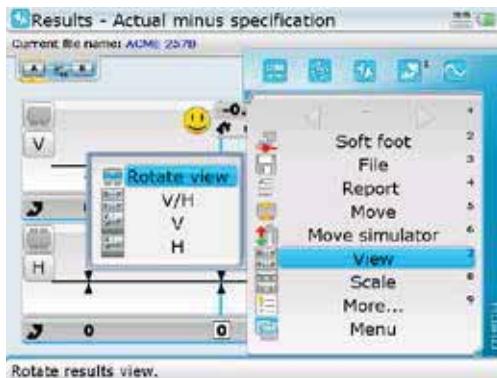

With 'Rotate view' highlighted, press  to confirm selection. After confirming selection, a video hint runs on the display. When the video run stops, the orientation on the display changes to match the opposite position.

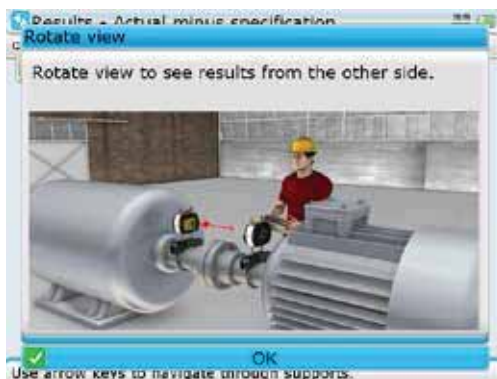

The video hint may be skipped by pressing  while the OK message displayed. The orientation on the display will still be changed.

Press  to confirm changing the orientation of the machines. Results will now be displayed as currently viewed by the user. This is from the opposite side of the original position.

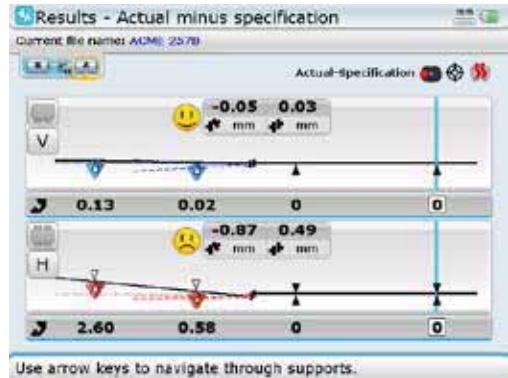
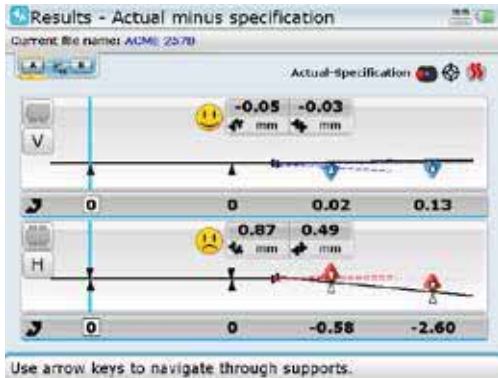

The screen on the left above, shows the initial orientation as viewed by the user, while the screen on the right above shows the current orientation after the 'Rotation view' function was applied. In the screen on the right, the machine designated stationary is now on the right hand side. Note that the vertical coupling gap values for both orientations remains unaltered as are the horizontal coupling offset values. The applied sign convention holds valid for both orientations.

Any applied 'Rotation view' functionality is temporary and is available only in the "Results", "Move" and "Move simulator" screens. As soon as one reverts to the either the "Set-up" or "Measurement" or "Soft foot" screens, the original machine orientation is assumed.



Note

4.13.1.6 VH views

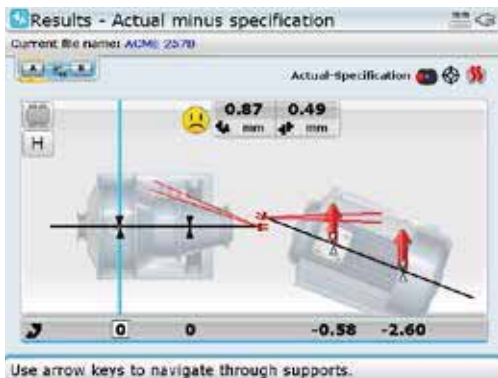

The different views may also be cycled by pressing



In this example following results options have been selected:
 'Show both left and right envelopes', 'Show machine icons', 'Show correction arrows'

4.13.2 Sign convention

The following sign convention is used in the evaluation of alignment results.

With left machine stationary, gap is positive when open at top or side away from viewer. The viewer is considered to be standing in front of the machines as they appear on the display.

Both vertical and horizontal results show the foot position relative to the stationary machine centerline. Positive values indicate that machine is upwards or away from viewer. Negative values indicate that machine is downwards or towards the viewer.

4.13.3 Alignment quality

The 'smiley' symbol by the coupling results indicates the degree to which the measured alignment condition meets tolerances. The smiley face appears only when tolerances have been enabled (see section 4.9).



Excellent



Acceptable



Out of tolerance

If all results lie within tolerance, no alignment corrections are necessary.



Note

4.14 Align machine

To align your machine you need to move it vertically by shimming the feet, and horizontally by shifting it sideways. You can perform these operations in either order or simultaneously.

4.14.1 Shim first

It is recommended to perform vertical corrections first, since the horizontal condition is easily affected by the process of loosening anchor bolts and inserting/removing shims, whereas the vertical condition is less prone to being affected when performing horizontal moves. You may need to recheck soft foot before proceeding.





Note

4.14.2a Move simulator

As the name suggests, the Move simulator is used to simulate shim values and horizontal movement corrections that are required to correct the alignment condition. The simulator takes into account the shim thickness available and the amount by which the machines can be physically moved.

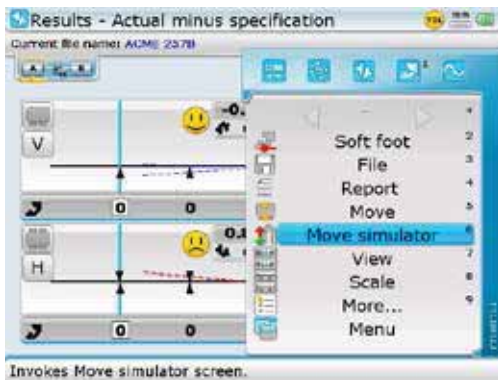

4.14.2b Initiating the Move simulator

Press  while in the results screen. The context menu appears. Use / to highlight the context menu item 'Move simulator'.



Invokes Move simulator screen.



Note that when selected and activated, the Move simulator starts with the vertical view. Use the context menu item 'View' present in both the "Results" and "Move simulator" screens to select the desired orientation.

Confirm selection by pressing . The "Move simulator" screen opens. To effectively use the Move simulator, it is necessary to set the required machine movement step. This value is set using the Move simulator screen context menu 'Move step'. Call up the context menu by pressing  while in the Move simulator screen.

68



Use arrow keys to navigate through the menu.

Use / to highlight the context menu item 'Move step' then press  to confirm selection. The next screen with the editing box appears.

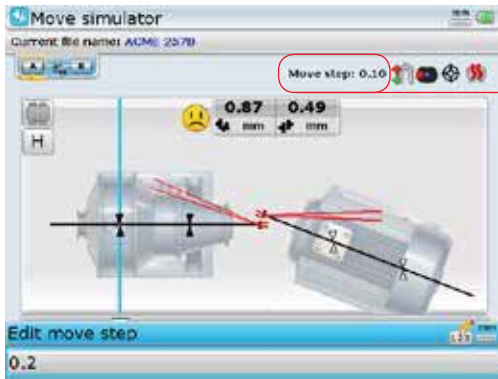

Default 'Move step' value

The activated tolerance envelopes are an assistance to determining the alignment condition of machines.

Use the data entry keys to enter the desired movement step value, confirming entry by pressing Enter or \uparrow .

The default 'Move step' value is 0.1 mm



Note

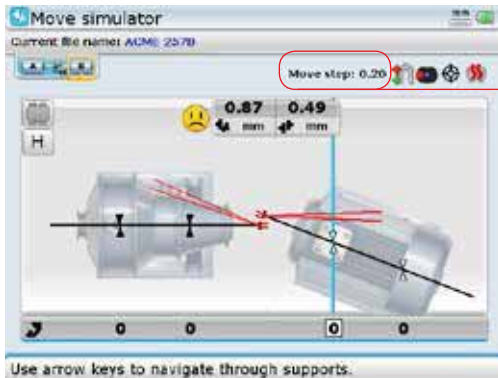

Set 'Move step' value

Use \leftarrow / \rightarrow to place the cursor on the feet pair requiring simulation. With the cursor on the selected feet pair, use Δ / ∇ to simulate the movement in accordance with the set step value. Pressing Δ moves the machine upwards (in vertical view) or away from viewer (in horizontal view) by the movement value factor. Pressing ∇ moves the machine downwards (in vertical view) or towards viewer (in horizontal view) by the movement value factor.

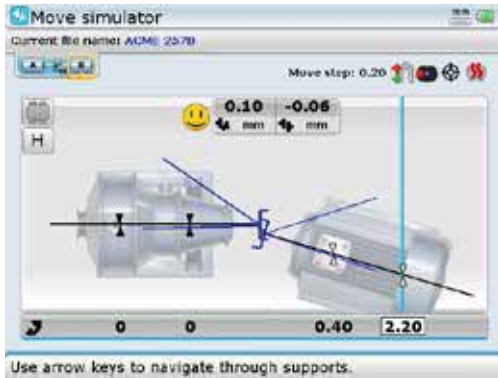

In this example, an excellent alignment condition has been achieved by raising the front feet 0.40 mm (2x the movement step value) and the back feet 2.20 mm (10x the movement step value).

Test shimming/movement values may be entered directly by highlighting feet pair to be shimmed/moved then confirming selection by pressing . The test values are entered in the editing box that appears.

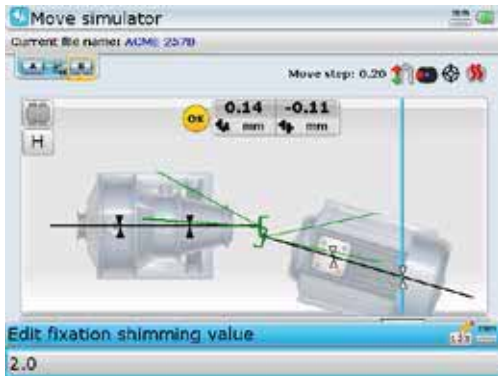

70

The Move simulator context menu contains items that are helpful in analysing a simulation. These include the menu item 'Reset values', the submenu items 'Rotate view' ['View' -> 'Rotate view'], 'Details' ['More...' -> 'Details'] and 'Options' ['More...' -> 'Options'].

Selecting 'Reset values' and confirming selection resets the simulator to the original result values.

Selecting 'Rotate view' allows the simulation of foot corrections from both sides of the machines (refer to section 4.12.1.5 'Rotate view').

Selecting 'Details' and confirming selection reveals the feet corrections to zero alignment, as well as any entered thermal growth values.

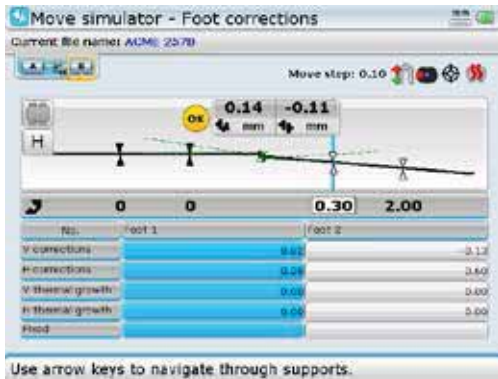

The correction values displayed from the submenu item 'Details' match those obtained using the Move simulator.

The Simulator options screen may be accessed via the Move simulator screen context menu item 'More...'. Select 'More...' -> 'Options' then press to confirm selection. The "Simulator options" screen opens.

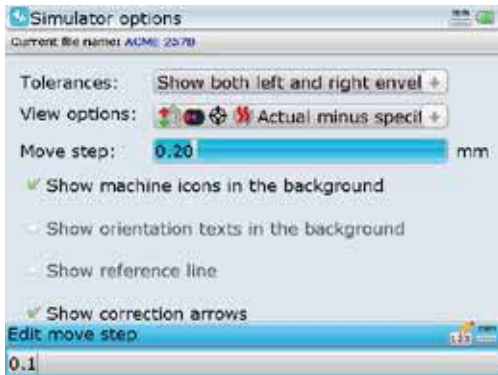

The "Simulator options" screen may also be used to edit the movement step value, activate the tolerance envelopes, set the results format and display machine icons in the background.

While in "Simulator options" screen, use the navigation keys to highlight the movement step value. With the value highlighted, use the data entry keys to edit this value. The editing box appears as soon as any data entry key is pressed. After editing the movement value, press or to confirm entry. Press to return to the Move simulator screen.

4.14.3 Horizontal and vertical live MOVE

The alignment corrections involving shimming and the lateral positioning of the machines can be followed in a real-time interactive display. From the results screen, press . The context menu appears. Use / to highlight 'Move'.

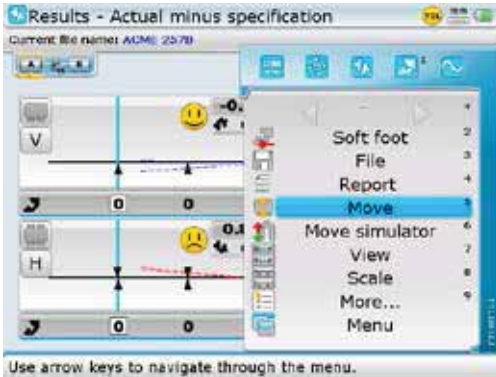

Press to confirm selection and start live Move.

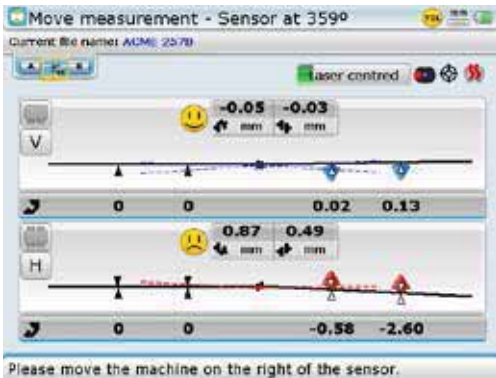

Live horizontal and vertical Move can be monitored simultaneously. Move is carried out in one direction (say vertical shimming first) then in the other direction (say horizontal Move).

Note that if the machines can be accessed from both sides, then the sub menu item 'Rotate view' ['View' -> 'Rotate view'] may be used to change the orientation of the machines on the display screen. For details refer to section 4.12.1.5 'Rotate view'.

If the laser beam is centered proceed to carry out live horizontal and vertical Move.

If however the laser beam is not centered, use the "Move measurement" screen context menu item 'XY view' (see section 5.2.7) to center the laser beam then press to go back to the results screen to proceed with live Move.



Note

Live Move may be stopped via the "Move measurement" screen context menu item 'Stop'. Use / to highlight the menu item 'Stop' then confirm selection by pressing .

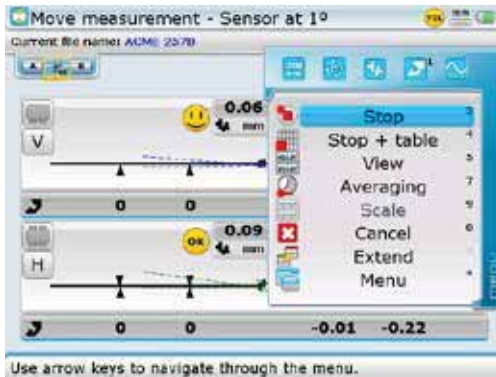

Note that the “Move measurement” screen context menu item ‘Averaging’ may be used to set the number of readings to be averaged. The context menu item ‘Extend’ may be used to broaden the laser beam detection range measurement range.

The features ‘Extend’ and ‘Averaging’ are described in sections 5.2.6 and 5.2.9 respectively.

ROTALIGN Ultra iS monitors both horizontal and vertical Live Move concurrently. If the results view is zoomed to the vertical view when the Move function is started, only the vertical condition will be displayed (although both planes are being monitored simultaneously). Likewise, if the results view is zoomed to the horizontal view when the Move function is started, only the horizontal condition will be displayed (but both planes monitored simultaneously). If the view is set to both vertical and horizontal (as illustrated above) then both conditions will be displayed. This information is recorded in the measurement table.



Note

4.14.4 Shimming

- i) Prepare the machines for shimming by ensuring the following:
 - The foot bolts are clean, intact and removable
 - Soft foot has been eliminated
 - The feet have enough shims under them should lowering the machine be necessary.
 - Good quality shims such as PERMABLOC, MYLAR or LAMIBLOC are available from PRÜFTECHNIK Alignment Systems
- ii) Loosen foot bolts while avoiding to move the machine horizontally. If any foot comes off the ground when loosened, suspect soft foot.
- iii) Use the vertical foot correction values to shim BOTH front and back feet as required. Positive feet values indicate that the feet are high and therefore shims should be removed, while negative feet values indicate that the feet are low and suggest addition of shim thickness.

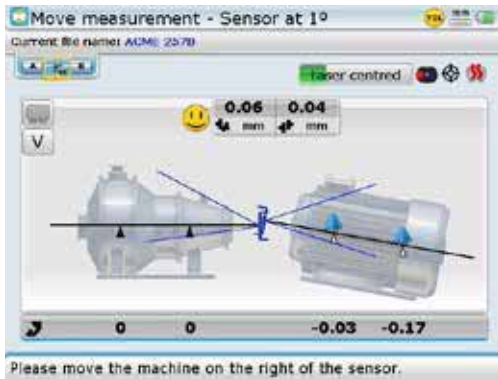

- iv) Retighten and remeasure to verify shimming results and determine the exact alignment condition.

4.14.5 Lateral positioning

- i) With foot bolts loosened, move machine feet keeping an eye on the smiley on the display screen.
- ii) Note the following sign convention – Positive feet values indicate that the machine feet should be removed towards viewer, while negative feet values suggest the moving of machine feet away from viewer.

Do NOT attempt to move the machine using heavy sledgehammer blows. This can cause bearing damage, and also produce inaccurate Move results. Jack bolts on the feet or other mechanical or hydraulic devices are recommended for moving machines.

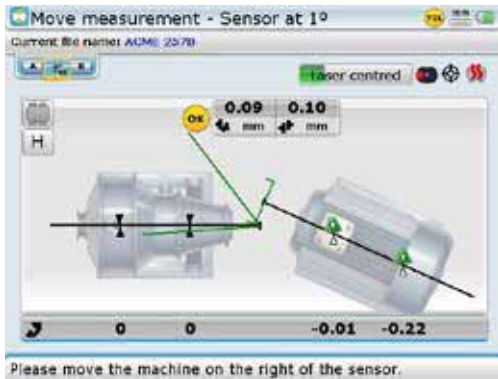



- iii) Tighten anchor bolts and recheck alignment by taking another set of measurements and viewing results. If they are in tolerance, then the machines are aligned.

4.15 Saving and printing measurement files

Before switching off the instrument, dimensions, measurements, results and all settings can be saved for analysis, future use or record purposes in the instrument's non-volatile memory.

Files can be set up and then saved with or without carrying out measurement.

If a measurement file was saved during set-up, the results may be saved after measurement as follows.

With results displayed, press  and use the navigation keys to highlight 'File'/'Save', confirming selection by pressing .

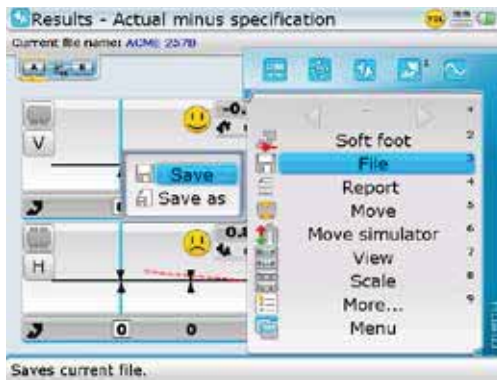

4.15.1 To save a file the first time

- Measurement files may be saved using the global menu. Open the global menu by pressing  twice. Use the navigation keys to highlight either 'File'/'Save as' or 'File'/'Save'

75

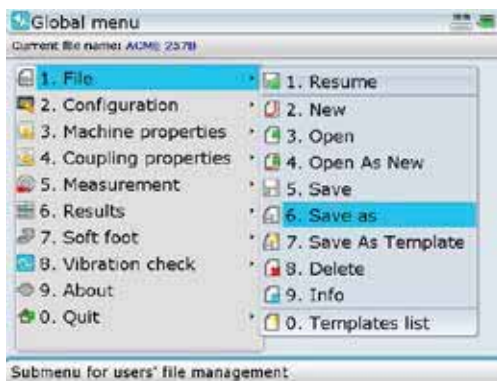

- Confirm selection by pressing . The "Save document as" screen appears.

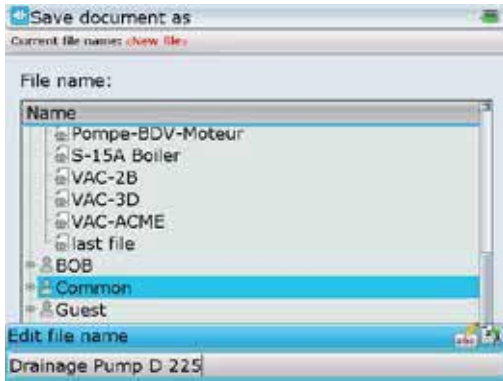

In this example, the measurement file 'Drainage Pump D225' has been saved in the folder 'Common'. Parent folders are created in 'User Accounts' which is accessed through 'Configuration' within the program manager (see section 8.2).

- c) Use Δ / ∇ to select a location to save the file. Press Enter then proceed to enter the file name using the data entry keys. Confirm file name by pressing either Enter or L .
- d) Measurement files may also be saved from the set-up screen. Press Menu while on set-up screen. The context menu appears. Use the navigation keys to highlight 'File' followed by 'Save'.



Press Enter to confirm selection. The "Save document as" screen appears and file may be saved as described previously in step (c) above.

4.15.2 Saving report as a PDF

- a) Measurement files may be saved directly from the system as a PDF copy.
- b) While within the application, press **L** repeatedly to open the machine configuration overview screen then press **Menu**. The context menu appears. Use **△**/**▽** to highlight the context menu item 'Report'.

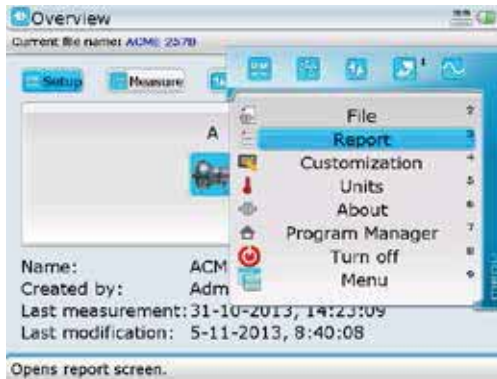

- c) With 'Report' highlighted, press **Enter** to confirm selection. The "Report" screen shown next appears.

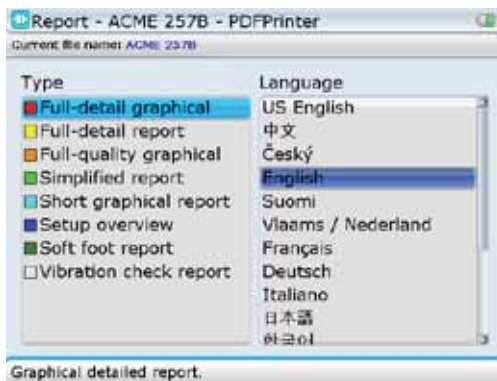

- d) Press **Menu** with the "Report" screen displayed. The context menu appears. Use **△**/**▽** to highlight the menu item 'Print as PDF file'.

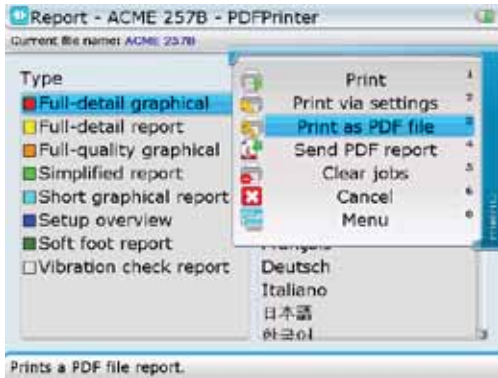

Note that the submenu items may be accessed directly by pressing the corresponding data entry key:

Note that when using the data entry keys for direct access, ensure that the ROTALIGN Ultra iS computer is connected to the necessary accessory as described here in section 4.15

- e) Before proceeding to print to PDF connect the 'short' ROTALIGN Ultra USB/peripheral devices cable ALI 12.503 to the ROTALIGN Ultra USB port. Attach the especially approved PRÜFTECHNIK Alignment Systems memory stick (aka jumpdrive) ALI 4.451 into the 'short' USB cable.

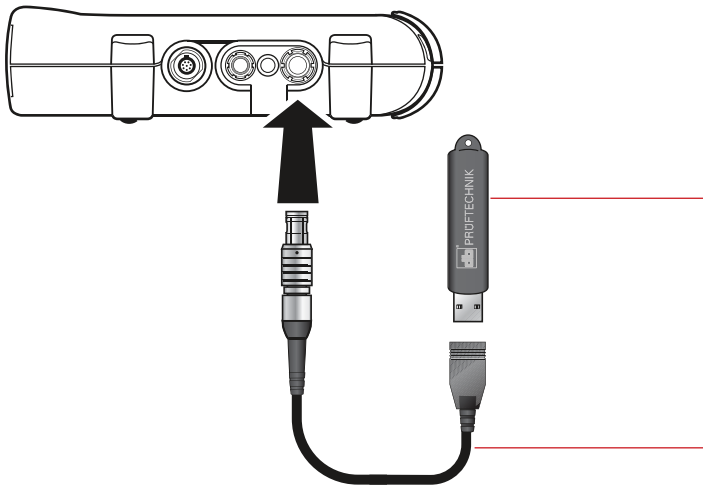

PRÜFTECHNIK Alignment Systems memory stick ALI 4.451.

Other PRÜFTECHNIK approved memory sticks may also be used.

ROTALIGN Ultra USB/peripheral devices cable ALI 12.503



- f) When all set, press . When printing to PDF is finished the message "PDF file has been saved" appears on the display. The report has now been saved onto the memory stick as a PDF copy and may be transferred to a PC for archiving or printing to any Windows compatible printer.

4.15.3 To print report after measurement

Measurement files can be printed either direct from the results screen or from the shaft alignment overview screen.

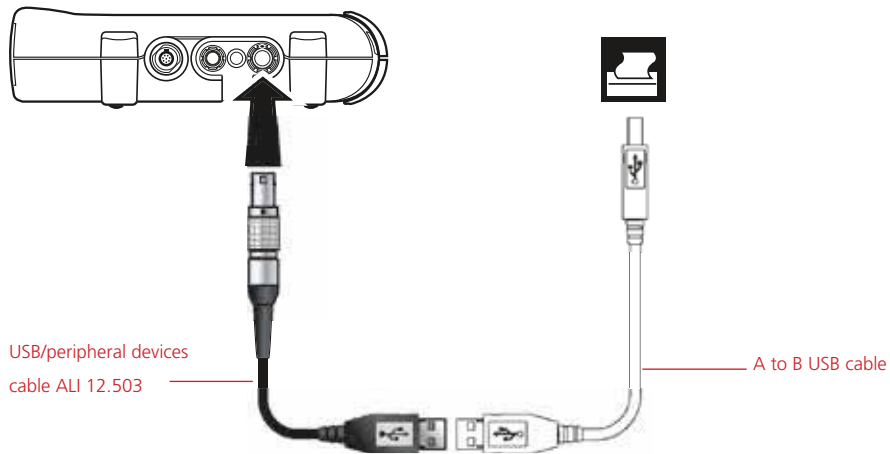
- Connect the ROTALIGN Ultra iS computer to your printer using the USB/peripheral devices cable ALI 12.503. Depending on your printer interface, you may require an A to B USB cable. Most printers are delivered with this USB cable which is also readily available from most electronic goods dealers.



- Press  repeatedly until the machine configuration overview appears on the display screen. Press . The context menu appears.

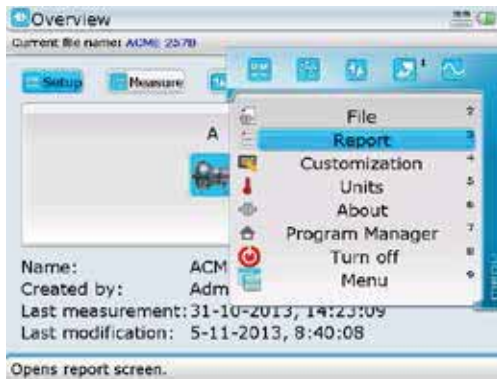

- Select 'Report' using either  /  then confirm selection by pressing .



Use </> to switch between the two panes.
 Use Δ/▽ to select the required report format and language. Item selected from any pane appears in blue when the opposite pane is highlighted.

In this example, the selected printer is 'PDF Printer'. This option is used to save the report as a PDF file. In this case, the printer settings must be configured to match the available printer.
 Note that if the available printer has been configured correctly, pressing prints report.

- d) Use the navigation keys to select language and type of report to be printed. The title bar shows the printer to which the report will be printed.

If the available printer has not been configured or if the printer configuration requires setting, use the "Report" screen context menu item 'Print via settings'.



The context menu item 'Send PDF report' is used to send the PDF report to other external Bluetooth devices such as mobile smart devices and PCs. To be able to send a report to the smart device, it must first be paired with the ROTALIGN Ultra iS computer.

Refer to section 8.1.7 for pairing Bluetooth devices to the ROTALIGN Ultra iS computer.

- e) With the context menu item 'Print via settings' highlighted, press then proceed to select the available printer from the printer name drop down menu.

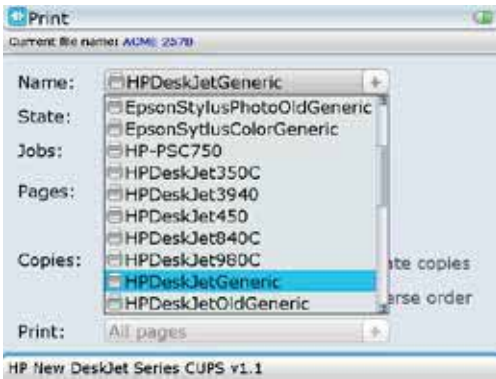

f) Confirm selection using the "Print" screen context menu item 'OK'.

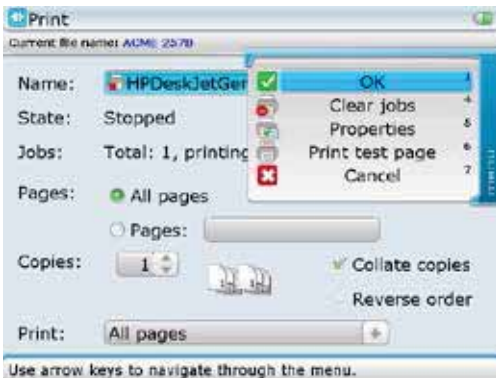

g) When ready, press  to print report.



If no report is printed, check the printer set-up described in section 8.1.5.

Graphical detailed report.

4.16 Alignment completion

After completion of an alignment measurement or job, press  and hold down for a moment to switch ROTALIGN Ultra iS computer off. Alternatively one may use the global menu combination 'Quit'/'Turn off device'. If the measurement file has not been saved, the following query appears:

- ▶ 'Do you really want to turn off the system?'

Selecting 'Yes' to turn off the system prompts the following question:

- ▶ 'Do you want to save changes in file?'

Save file if required for record and analysis. If it is not required, selecting 'No' turns off the system.

- ▶ Switch both sensALIGN laser and sensor off and slide back both laser and sensor dust caps to cover the apertures.

Remove the components from the shafts and store them in the case.
Replace guards before you switch the machine back on.



WARNING





Chapter 5: Alignment features

5.1 Measurement modes

ROTALIGN Ultra iS Shaft offers the following Shaft level dependent measurement modes: Continuous Sweep, IntelliSWEEP, Multipoint, Static (0,3,6,9), IntelliPOINT, IntelliPASS and Dial gauge measurement mode.

The intelligent measurement modes IntelliSWEEP, IntelliPOINT and IntelliPASS are only available in Advanced and Expert Shaft levels.

IntelliSWEEP is the default measurement mode in both Advanced and Expert Shaft levels while Continuous Sweep is the default measurement mode in Standard Shaft level.

The measurement modes are accessed via the measurement screen. Press  to access the measurement screen. While on this screen, press . The context menu appears. Use / to highlight the context menu item 'Measurement mode'.

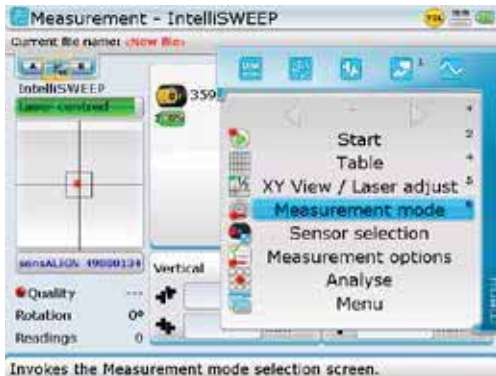

Invokes the Measurement mode selection screen.



Press  to confirm selection.



Use arrow keys to choose the measurement mode.

IntelliSWEEP is discussed in detail in section 5.1.1, while IntelliPOINT and IntelliPASS are discussed in section 5.1.4 .

Note that in the Expert licence version, the "Measurement" screen context menu items 'Measurement mode' and 'Measurement options' are displayed as sub menu items clustered in the context menu item 'Mode/Options'.

Use / to select the required measure mode. Note that the cursor can be moved along the measurement modes only when a measurement mode is highlighted. Confirm selection by pressing .

The “Measurement mode” screen may also be used to set up the following measurement properties:

- ▶ Type of Sweep mode to be used – this can be either ‘IntelliSWEEP’ or the customary ‘SWEEP’ method.
- ▶ The duration in which readings are to be averaged – the longer the duration of the averaging, the higher the number of readings collected. This feature applies to ‘point’ measurements such as ‘IntelliPOINT’, ‘Multipoint’ and ‘Static mode’.
- ▶ Measurement factor – this is expressed as either ‘Quality’ or ‘Standard Deviation’ (SD)
- ▶ Dial indicator set-up used – these include ‘Rim and Face’ and ‘Reverse Indicator’ configurations.

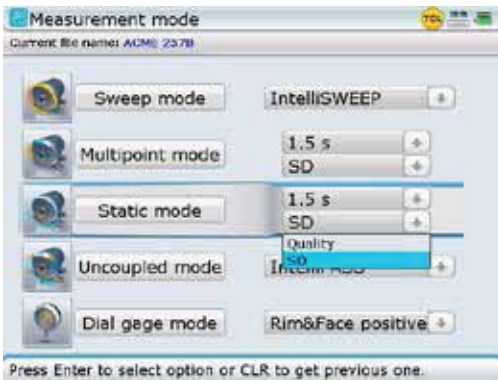

The measurement properties appearing on the right side of the screen are measurement mode dependent. To set the properties for any particular measurement mode, press with the particular measurement mode highlighted. The cursor box moves as shown opposite to enclose the related measurement properties.

Use / to select the required measurement property then press to display the drop down menu. Use / to highlight desired property then confirm selection by pressing . Exit the measurement property box by pressing .

5.1.1 IntelliSWEEP

IntelliSWEEP is a measurement method that actively assists the user by automatically detecting errors and providing guidance on how to avoid such errors. The method also eliminates error influences such as coupling backlash, machine rotational angle and environmental vibration, resulting in extremely precise measurement results. The method is used to measure all standard machines.

Other IntelliSWEEP features include:

- ▶ Intelligent filtering and averaging of results – this leads to high data reduction without loss in measurement accuracy
- ▶ Detection and elimination of coupling backlash and friction resulting from abrupt starts and stops during shaft rotation
- ▶ Monitoring both shaft rotational speed and direction during measurement
- ▶ Providing real time quality values during measurement
- ▶ Monitoring and measuring machine train vibration

IntelliSWEEP features are available only if ROTALIGN Ultra Advanced Shaft firmware has been installed and licenced in the ROTALIGN Ultra iS computer. This is done by acquiring the ROTALIGN Ultra Advanced Shaft firmware certificate ALI 4.741.



Note that measurement may be started automatically when the shafts are rotated or triggered manually by pressing .

This preference may be set in the "Measurement options" screen accessed via the "Measurement" screen context menu item 'Measurement options'.

After adjusting the laser beam and initializing sensALIGN sensor as described in sections 4.10 and 4.11 in chapter 4, rotate shafts to take measurement. In IntelliSWEEP, hints are displayed to guide the user through an error-free measurement. The quality of the measurement as well as real time coupling values are displayed on the screen.



The following IntelliSWEEP features are displayed on the measurement screen:

- 1 A rough rotation icon
- 2 Corresponding hint
- 3 Measurement quality
- 4 Real time coupling results

Measurement quality may be analysed in details via the "Measurement" screen context menu item 'Analyse'. While in "IntelliSWEEP Measurement" screen, press . The context menu appears. Use the navigation keys to highlight 'Analyse' -> 'Detailed quality'.

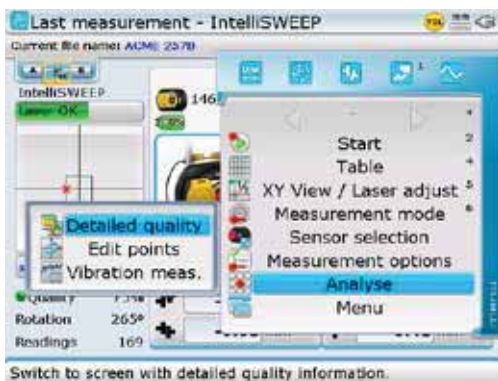

Measurement can be analysed only after it has been stopped. To stop a measurement, use the context menu item 'Stop' which appears in the "Measurement" screen during measurement.

Note that in the Expert licence version, the "Measurement" screen context menu items 'Measurement mode' and 'Measurement options' are displayed as sub menu items clustered in the context menu item 'Mode/Options'.

With 'Detailed quality' highlighted, press  to confirm selection. The "Measurement quality" screen opens. The screen displays all the factors and the respective weighting used to determine the measurement quality.



In this example, when all quality factors have been considered, the resulting measurement quality of 75% is classified as excellent with the colour code blue.

Measurement quality is depicted using the following colour codes:



-  — excellent
-  — acceptable
-  — not acceptable
-  — poor

Measurement quality is based on the following measurement and environmental criteria:

- ▶ Rotation angle – the angle through which sensALIGN sensor/shaft is rotated during measurement
- ▶ Ellipse standard deviation – the root mean square deviation of the measurement points on the calculated ellipse
- ▶ Environmental vibration – the level of external vibration e.g. from neighbouring running machine(s)
- ▶ Rotation evenness – the smoothness of the measurement rotation e.g. if there is any friction during the rotation that ‘jerks’ the shaft
- ▶ Angle rotation inertia – abrupt changes in the measurement rotation speed e.g. releasing and re-applying a break during the rotation
- ▶ Rotation direction – change in the measurement rotational direction
- ▶ Rotational speed – how fast sensALIGN sensor/shaft is rotated during measurement
- ▶ Filter output – the amount of measurement data filtered out

5.1.2 Multipoint measurement

This mode is used to measure shafts which are either difficult to turn continuously or allow measurement only in certain rotational positions. The method can also be used to measure uncoupled shafts, nonrotatable shafts, sleeve bearings, white metal bearings and journal (radial) bearings, shafts that are difficult to turn, shafts with herky-jerky rotation, situations with long spans or severe misalignment that will readily cause the beam to fall out of range.

After centering the laser beam as described in section 4.10, press  to take the first measurement point. Rotate shafts in their normal direction of operation from one measurement position to the next. Press  to take measurement at each new position. Measurements must be taken in at least three positions over at least 60° of rotation, but more measurements over a wider angle is recommended.



After finishing measurement, press  to view results.

5.1.3 Static measurement

This measurement mode is used for uncoupled shafts, nonrotatable shafts and vertical foot-mounted or flange-mounted machines.

After centering the laser beam as described in chapter 4, turn the shaft to any of the eight 45° positions (i.e. 12:00, 1:30, 3:00, 4:30, 6:00, 7:30, 9:00 or 10:30 o'clock position viewed from sensor towards laser). Position shaft as accurately as possible using either an external inclinometer or protractor. Press  to take the first measurement point.

Rotate shaft to the next measurement position. Use the navigation keys to position the displayed sensALIGN laser and sensor at an angular rotation corresponding to the actual position of the components as mounted on the shafts.

Take next measurement point by pressing .

Note that after  has been pressed, the displayed sensALIGN laser and sensor move to the next clock position on the display.

If shaft rotation restrictions hinder the taking of measurements at particular shaft positions, bypass these using the navigation keys.

While in the “Measurement mode” screen you may also set-up the averaging duration and the measurement factor.

Coupling results are displayed after a rotation of at least 60°. If using standard deviation (SD), the value appears after 4 or more readings. For best results take 5 or more points. The more points that are taken the more points can be deleted in the “Edit points” screen to maximize accuracy. A detailed description of this utility appears under ‘Edit raw data’ in section 5.2.5.

Note that after  has been pressed, the displayed sensALIGN laser and sensor move to the next clock position on the display. Use the navigation keys to position both laser and sensor manually.



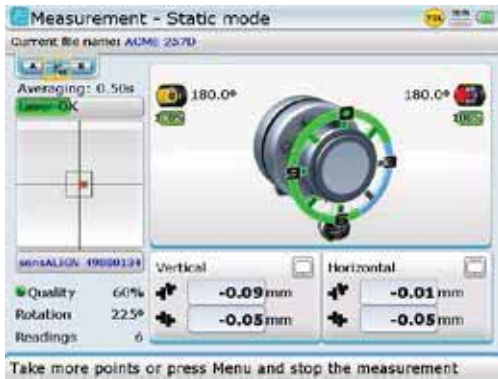

The navigation keys are used to position the laser unit on the display screen to correspond to the actual shaft position. Measurement may be stopped or finished using the context menu item "Stop measurement"

Measurements must be taken in at least three positions over 90°, but more measurements over a wider angle is recommended. After finishing measurement, press **RES** to view results.

5.1.4 Uncoupled mode

Uncoupled shafts can best be measured in the Uncoupled mode, where the measurement heads (sensALIGN laser and sensor) are rotated past one another in several different rotational positions. The Uncoupled mode offers two distinct measurement methods; 'IntelliPASS' and 'IntelliPOINT'. The measurement heads can be mounted in a variety of ways depending on the alignment situation.

Note that 'IntelliPASS' and 'IntelliPOINT' are available in Advanced and Expert Shaft levels only.

5.1.4.1 IntelliPASS

IntelliPASS is used in cases where the uncoupled shafts cannot be stopped at definite positions. In this mode, the shaft supporting the laser is rotated so that the laser beam strikes the sensor lens as it passes it. Measurements are taken when the laser beam passes through the middle sector of the detector.

After centering the laser beam as described in section 4.10, rotate the shaft supporting one of the measurement heads (say laser) to the first position, then rotate the shaft supporting the other head (say sensor) slowly past the opposite head. As the laser beam strikes and passes the sensor detector, the four sensALIGN sensor laser beam adjustment LEDs on the front of its housing blink green depending on the position at which the beam strikes the detector.

Rotate either head to the next measurement position; repeat the procedure to take measurements through at least three positions over at least 60° of rotation, but more measurements over a wider angle is recommended.



The path traced by the laser beam as it passes the sensor is plotted on the detector display. Readings are taken in the middle sector of the detector surface. This is the section where laser position appears as green dots. Readings are not taken where laser position appears as yellow dots.

After finishing measurement, press **(RES)** to view results.



Note

If only one shaft is not easily rotatable while the other can be freely rotated, always mount the sensor on the nonrotatable shaft (use the magnetic sliding bracket ALI 2.230). Do NOT mount the laser emitter on the not-easily-rotatable shaft, even if this means setting up your laser and sensor opposite to the way you normally would for alignment purposes. You can always invert the movable and stationary machines by using the static feet utility in the results screen. Enter all dimensions in accordance with your actual set-up, following the normal orientation of the laser and sensor in the dimensions screen.

It is recommended to take several sets of readings and then compare them for repeatability in the measurement table (accessible from the "Measurement" screen context menu item 'Table'. If necessary average together multiple sets of readings for greater accuracy.

Uncoupled shafts:

Mount laser and sensor using chain-type brackets

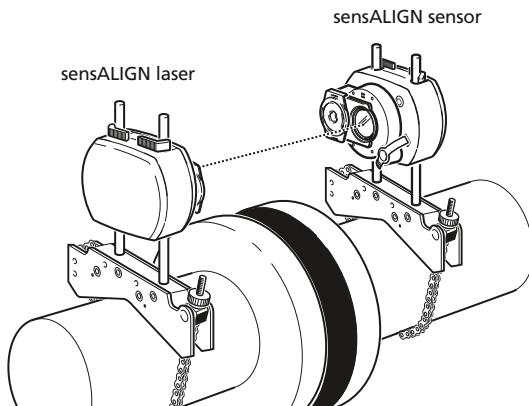

For not easily rotatable shaft(s):

Mount sensor using magnetic sliding bracket ALI 2.230.

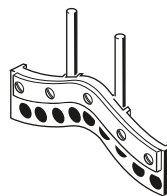

Magnetic sliding bracket ALI 2.230

5.1.4.2 IntelliPOINT

IntelliPOINT is used in cases where the uncoupled shafts can be stopped at definite positions. It is also used in cases where the shafts are coupled but torsional play exists. This mode ensures that measurement points remain on the same rotational arc hence increasing accuracy.

In this mode, the shaft supporting the laser is rotated to the position where the laser beam strikes the center of the sensor lens. Measurement is taken when the laser beam strikes the center of the detector.

After centering the laser beam as described in section 4.10, the 'Take point' button appears on the screen.



Note that in the initial IntelliPOINT measurement screen, the 'Take point' button appears on the display when the laser beam is centered. The on-screen needle indicator provides additional help in adjusting the laser beam. The laser beam should be initially centered such that the needle rests in the central green sector.

With the 'Take point' button highlighted, press  to initiate the measurement arc by taking first measurement point.



Rotate the shaft supporting one of the measuring heads (say sensor) to the next position, then rotate the shaft supporting the other measuring head (say laser) until the needle rests in the central blue sector of the on-screen needle indicator. When the needle is in the blue sector, and value stabilization time has been attained, the 'Take point' button appears on the display. At this point, the laser beam strikes the sensor detector at the same arc position as the initial point and the beam coordinates are stable.



From this point onwards, the 'Take point' button only appears on the display when the needle is in the central blue sector of the on-screen needle indicator, and the value stabilization time is attained.

With the 'Take point' button highlighted, press  to take second measurement point.

Rotate either head to the next measurement position; repeat the procedure to take measurements through at least three positions over at least 60° of rotation, but more measurements over a wider angle is recommended.



After finishing measurement, press  to view results.

5.1.5 Dial gauge mode

This mode is used to convert dial gauge readings into ROTALIGN Ultra iS Shaft values, hence verifying calculations and comparing measurement results with those obtained using ROTALIGN Ultra iS Shaft. It can also be used to convert ROTALIGN Ultra iS Shaft alignment results into the commensurate dial gauge readings.

5.1.5.1 Converting dial gauge readings into ROTALIGN Ultra iS Shaft values

1. Press to open the measurement screen. With the measurement screen open, press . The context menu appears. Use / to highlight the context menu item 'Measurement mode', then press to confirm selection. From the measurement mode screen that appears, use the navigation keys to select 'Dial gauge mode' and the desired dial indicator configuration.

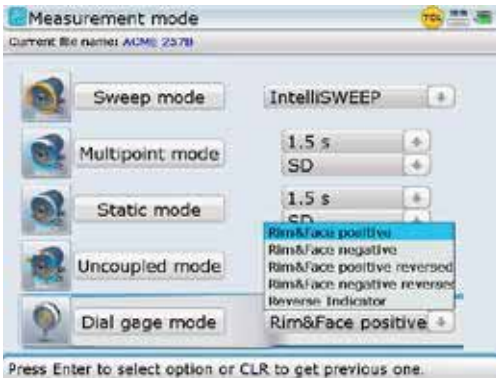

2. Press to confirm the set-up then exit to the "Dial gauge measurement" screen by pressing .

92

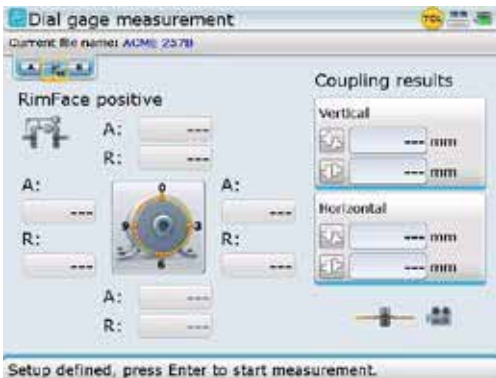

3. When back to the "Dial gauge measurement" screen, press then use / to highlight the context menu item 'Dial gauge set-up'.



- Press Enter to confirm selection, then proceed to enter required axial and radial dimensions, and sag values using the data entry keys .

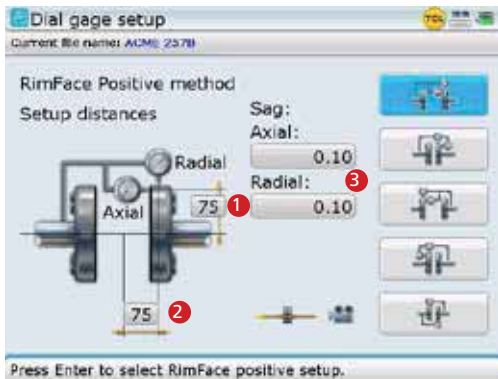

1 In this method, enter the radius of the axial gauge from the shaft center.

2 Here, we enter distance from the radial gauge to the coupling center.



3 Enter radial and axial sag values.

Values are entered directly using the data entry keys and confirmed by pressing either Enter or t .

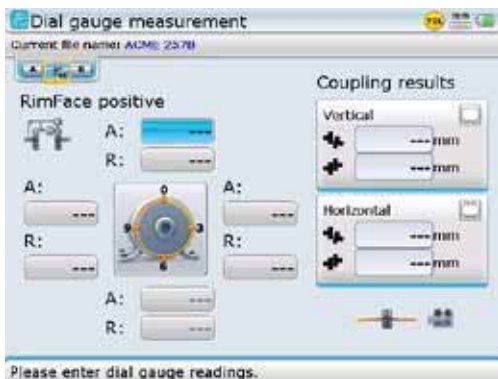

- After entering the required dimensions and the amount of bracket sag, press t to return to the dial gauge measurement screen. To enter the dial gauge values, press Enter . The cursor highlights the 12:00 o'clock rim value box.

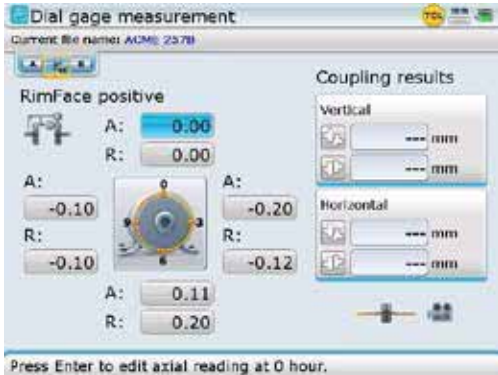

Alternatively, use the "Dial gauge measurement" screen context menu item 'Start' to begin entering the dial gauge values.

- Proceed to enter the dial gauge reading directly using the data entry keys. Confirm entry by pressing either  or . The next empty entry box is highlighted. You may use the navigation keys to cycle through the value entry boxes.



- To view ROTALIGN Ultra iS Shaft gap and offset coupling values, press , then use / to highlight the context menu item 'Stop'.

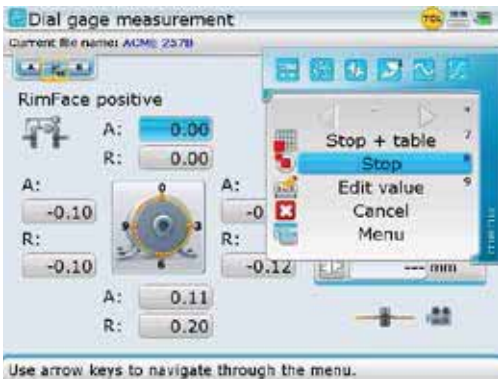

- Confirm selection by pressing . Coupling results are displayed.

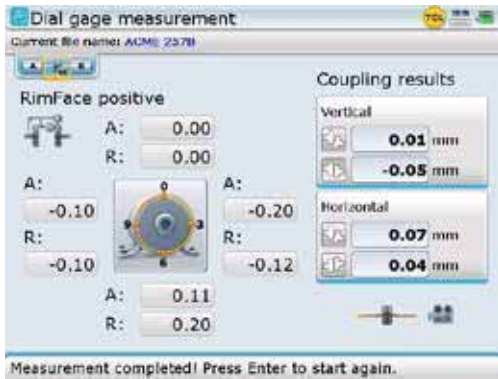



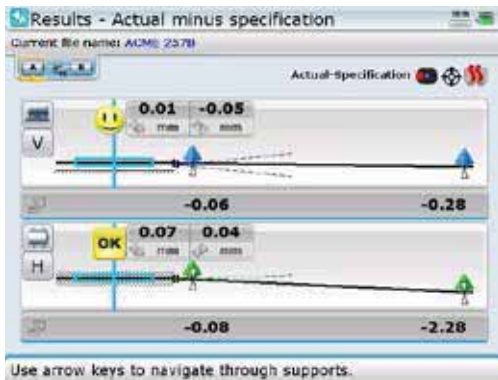

9. Press **RES** to view foot results.







Pressing **RES** reveals the results screen showing feet positions if the dimensions have already been entered. If dimensions are missing, the set-up screen prompting dimensions appears.

5.1.5.2 Converting measurement table readings into dial gauge readings





It is also possible to convert existing measurements from the measurement table into dial indicator readings for comparison and analysis.

Access the “Measurement table” screen via the global menu [‘Measurement’ -> ‘Measurement table’] or the “Measurement” screen context menu item ‘Table’. While in the “Measurement table” screen, use / to highlight measurement whose values are to be converted into dial indicator readings then press . Use / to highlight the item ‘Gauge values’ from the context menu that appears.

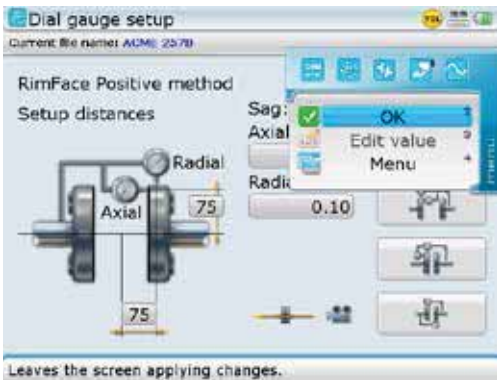

On confirming selection by pressing , a hint appears requesting the set-up of the dial gauge configuration. Use / to highlight ‘Yes’ then press  to confirm selection. The “Dial gauge set-up” screen appears.



Enter the axial and radial dimensions, and the respective sag values then press . Use / to highlight the context menu item ‘OK’. Press  to confirm selection and display the corresponding dial indicator readings.

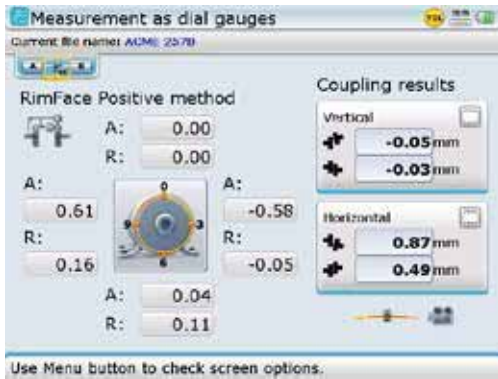

In this example, the dial indicator readings for the 'rim and face positive' method for the given coupling results are displayed.

Note that if a dial gauge set-up already exists within the measurement table, dial indicator readings for any highlighted measurement will be displayed instantly when the context menu item 'Gauge values' is selected.

5.2 Measurement options

5.2.1 Measurement table

All measurements taken on the current set of machines are registered in a measurement table which can be viewed directly following measurement.

The measurement table is accessed through the "Measurement" screen context menu item 'Table'. Press **Menu** while on "Measurement" screen, then use **▲** / **▼** to highlight the context menu item 'Table'.

Measurement table can also be accessed via the global menu. Press **Menu** twice to open the global menu, then select 'Measurement' -> 'Measurement table'.

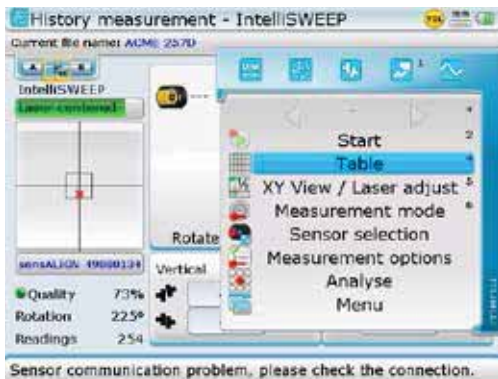

Press **Enter** to view the measurement table.

Measurement table of coupling 1

Current file name: A12M1 25.79

	Vertical	Horizontal			
		Gap	Offset		
1	↻	-0.06	-0.18	0.84	0.98
2	↻	-0.05	-0.12	0.83	0.92
3	↻	-0.04	-0.08	0.84	0.88
4	↻	-0.06	-0.11	0.82	0.88
5	↻	-0.29	-0.35	-0.71	-0.75
6	↻	0.14	-0.72	1.22	-0.91
7	↻	-0.07	-0.11	0.84	0.91
Average		-0.04	-0.08	0.84	0.88

Press Enter to include/exclude measurement from averaging.

Measurement table of coupling 1

Current file name: A12M1 25.79

	Cal	Offset	Quality		SD	Distance	Sensor
			QF	SD			
1	35	0.98	20%	0.053	185	sensAl	
2	33	0.92	54%	0.124	185	sensAl	
3	34	0.88	73%	0.069	185	sensAl	
4	32	0.88	86%	0.009	185	sensAl	
5	71	-0.75	60%	0.395	185	sensAl	
6	22	-0.91	50%	0.166	185	sensAl	
7	34	0.91	20%	0.079	185	sensAl	
Average		0.84	0.88	---	---	---	



Press Enter to include/exclude measurement from averaging.

The measurement table is scrolled downwards, upwards and sideways using the navigation keys. The contents of the measurement table from left to right include the measurement position (indicated by nos. 1,2,3 ...), measurement mode (or live move) – indicated by symbols, vertical and horizontal coupling values, measurement quality factor, standard deviation, distance from coupling center to sensor, used sensALIGN sensor serial number, the duration of the used averaging, use of the extend range, direction of shaft rotation during measurement, date and time when a particular measurement was taken, labels used, calibration due dates for the sensALIGN sensor used, and used sensALIGN laser serial number.

Up to 50 measurements can be stored in a measurement table. Changes made in the set-up screen affect only later results, not earlier ones.

Multiple measurement sets can be averaged to achieve more representative results. This feature is particularly useful for uncoupled shafts or when bearing play is considerable. To calculate this average, proceed as follows:

98



1. Use  /  to highlight a measurement for inclusion in the average.
2. Press  to select the measurement. A check mark appears next to the measurement position indicating that the measurement has been included in calculating the average.
3. Repeat steps 1 and 2 for all other measurements to be included.

Measurement table of coupling 1

Current file name: A12M1 25.79

	Vertical	Horizontal			
		Gap	Offset		
1	↻	-0.11	-0.18	0.95	0.98
2	↻	-0.05	-0.12	0.83	0.92
3	↻	-0.04	-0.08	0.84	0.88
4	↻	-0.06	-0.11	0.82	0.88
5	↻	-0.29	-0.35	-0.71	-0.75
6	↻	0.14	-0.72	1.22	-9.06
7	↻	-0.07	-0.11	0.84	0.91
Average		-0.05	-0.10	0.83	0.90



Press Enter to include/exclude measurement from averaging.

To remove a measurement from the average calculation, highlight the measurement using / then press . The check mark next to the measurement position disappears indicating that the measurement is not included in calculating the average.

It is not possible to average readings taken before a Move with readings taken after a Move.



Note

Measurement points, alignment records, and the coupling to sensor distance can be edited from the measurement table screen. To access these items, press  while in the 'Measurement table' screen. Use / to highlight item required from the context menu that appears.

The context menu items of the "Measurement table" screen are applied to the measurement currently highlighted on the measurement table.

The measurement table may also be accessed directly via the global menu items 'Measurement' -> 'Measurement table'

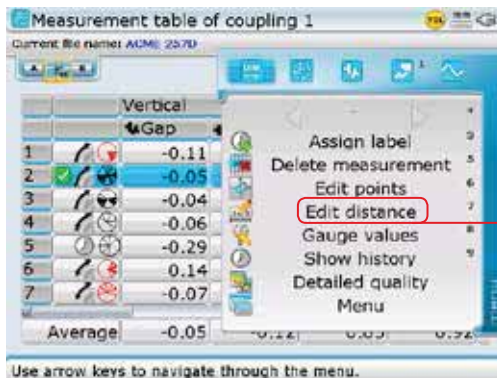

Note that the function 'Assign label' can be effected only on checked measurements.









The measurement table context menu item 'Edit distance' is used to edit the dimension coupling center-to-sensor.

This function makes it possible to display the corresponding results without necessarily having to remeasure.

5.2.2 Measurement history

To help keep measurement and alignment records, use is made of the "Measurement table" screen context menu item 'Assign label'. Using this feature, it is possible to apply labels to particular measurements avoiding confusion when analysing alignment records.

To assign a label to a measurement, proceed as follows:

1. Access the measurement table from the measurement screen by pressing  while in the measurement screen. From the context menu that appears, use / to highlight 'Table', then press  to confirm selection. Use / to highlight measurement to be assigned a label, confirming by pressing . A check mark appears next to the measurement.
2. Press  then use the navigation keys and highlight 'Assign label' from the context menu that appears.



In this example, measurement no. 2 which has been highlighted and checked is to be assigned a label.

3. Press to confirm selection. A dialog window with predefined labels appears.



If desired, customized labels may be defined using the 'Edit label' button.

100 4. Use / to highlight the appropriate label. Confirm selection by using / to highlight 'OK', then press to accept label.

5.2.2.1 Editing label

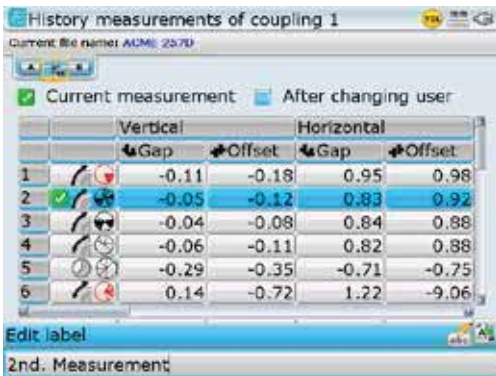

In this example, measurement no.2 previously had the label 'After changing user'. This is now being edited via the 'Edit label' button to '2nd Measurement'.

5.2.3 Deleting measurement

1. With the measurement table displayed, use Δ / ∇ to highlight measurement to be deleted.
2. Press Menu then use Δ / ∇ to highlight the context menu item 'Delete measurement'.

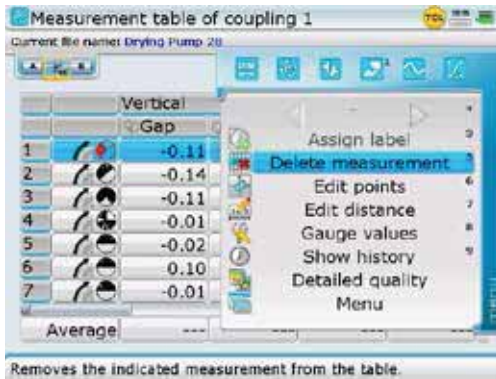

Highlighted measurements may also be deleted by pressing CLR .

3. Press Enter to confirm selection. A hint box requesting confirmation to delete measurement appears. Use the navigation keys to highlight 'Yes'. With 'Yes' highlighted, pressing either Enter or t deletes the measurement permanently.

5.2.4 Identifying history labels

To find out how many different labels have been assigned in measurement history table, proceed as follows:

1. With measurement table displayed, press Menu then use Δ / ∇ to highlight 'History labels'.

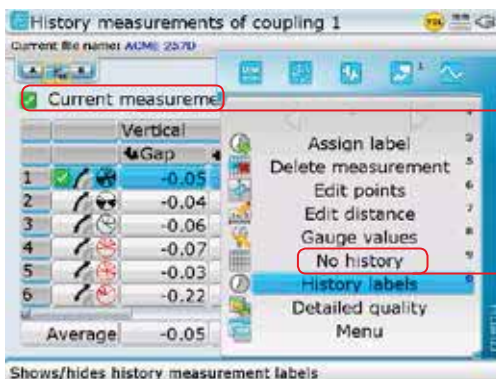



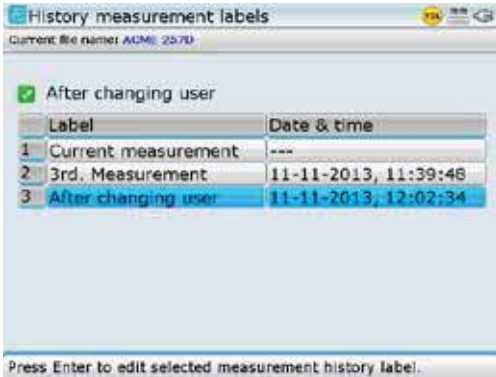

History label to highlighted measurement

Note that the context menu item 'No history' toggles with the context menu item 'Show history'. If 'Show history' has been selected (as in this example), then the label to the highlighted measurement appears at the top of the table.

2. Press  to confirm selection. The "History measurement labels" screen appears showing all labels used in the file.



3. To identify the measurement related to a particular label, use / to highlight the respective label, then press . Use / to highlight the context menu item 'History measurements'.



4. Press  to view the measurement under the selected label (in this case 'After changing user').

	Vertical	Horizontal		
	Gap	Offset	Gap	Offset
1	-0.05	-0.12	0.83	0.92
2	-0.04	-0.08	0.84	0.88
3	-0.06	-0.11	0.82	0.88
4	-0.07	-0.11	0.84	0.91
5	-0.03	0.81	0.85	1.57
6	-0.22	0.80	-0.46	-1.06
Average	-0.05	-0.12	0.83	0.92

me	History labels	Calibration c
1	3, 9:20:19 After changing user	23-1-2015
2	3, 9:22:26 3rd. Measurement	23-1-2015
3	3, 9:53:38 After a break	23-1-2015
4	3, 10:52:43	23-1-2015
5	3, 10:53:36	23-1-2015
6	3, 14:13:02	23-1-2015

The measurement with the label 'After changing user' is measurement no. 1 (with check mark) on the measurement table. Use to horizontally scroll the measurement table.

5.2.5 Edit raw data

To improve the quality of the alignment results, it may be necessary to edit measurement data that is suspect or was affected by external circumstances. After completion of measurement, use the "Measurement screen" context menu item 'Stop + table' to access the measurement table. With the particular measurement highlighted, press then use to highlight the menu item 'Edit points'.

The measurement table may also be accessed via the global menu. Access the global menu by pressing twice then select 'Measurement' -> 'Measurement table'.

	Vertical
	Gap
14	-0.33
15	-0.11
16	-0.20
17	0.01
18	0.01
19	-0.08
20	-0.06
Average	-0.06

Note that the points displayed on the "Edit points" screen are for the highlighted measurement (in this case, the blue cursor is on measurement no. 20) and not the checked measurement.

Press to view and edit ellipse points.

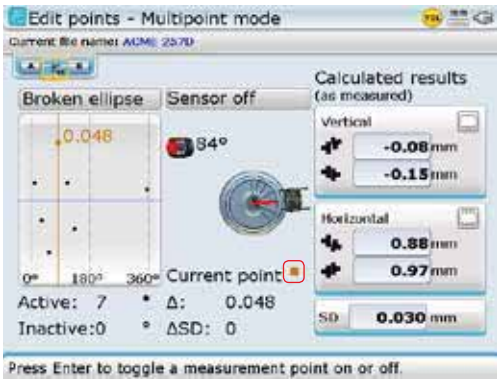

In this example, the selected ellipse view mode is a broken ellipse. The currently selected point is active (bold dot), and deviates by 0.048 mm. The standard deviation SD is 0.030.

Any measurement point that deviates severely from the other values can be deactivated from the measurement set.

Use the navigation keys to select the measurement point to be deactivated. Any selected point can be deactivated by pressing .

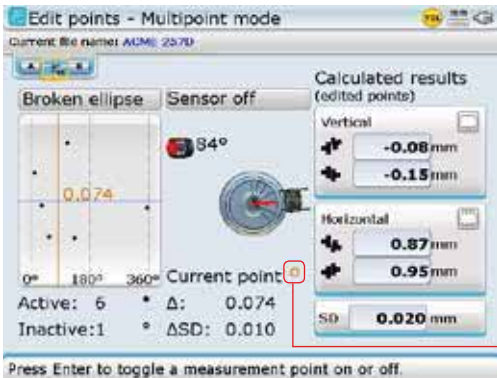

In this example, the deactivated point is the one that was highlighted in the previous example. The point appears as a clear circle on the display and SD has improved to 0.020. The change in SD is recorded on the screen.

The current status of the marked point is displayed on the screen allowing the reactivation of points by pressing . A solid dot indicates an active measurement point. A hollow dot with a white center indicates a disabled or inactive point.

The context menu of the "Edit points" screen includes the items 'Ellipse view mode', 'Toggle point', 'Max point' and 'Sensor on/off'.



The menu item 'Detailed quality' is used to access the "Measurement quality" screen which can also be accessed via the "Measurement" and "Measurement table" screens shown previously.

The 'view mode' allows raw data to be examined from three different views. The three views are: ellipse and corresponding points, plane points and broken ellipse. Use the navigation keys to highlight the desired view then confirm selection by pressing Enter . In the "Ellipse and points" view, the width of the ellipse along the X axis gives an indication of shaft angularity, and its height (on the Y axis) indicates shaft offset. When shafts are perfectly aligned, the ellipse is reduced to a single point.

'Toggle point' is used to deactivate any selected measurement point. Use Δ / ∇ to highlight 'Toggle point', then press Enter to deactivate the selected point. This point may be reactivated by the same procedure. The 'deactivated' measurement position can be remeasured in the 'Multipoint', 'Pass' and 'Static' measurement modes. If several 'active' points result for the same position, they will be averaged together.

'Max point' is used to highlight the measurement point with the maximum deviation from the calculated ellipse.

Selecting **'Sensor on'** shows the current beam position on the screen. With this function, repeatability can be checked by following the path of the beam as the shafts are turned through the measurement positions again. The beam should move along the curve of the ellipse without appreciable deviation.

5.2.6 Extending the measurement range

Gross misalignment of shafts or small angular misalignment over large distances can cause the laser beam to miss the detector surface during measurement. When this happens, 'Laser end' appears on the display screen and the instrument's 'Extend' function can be used.

The 'Extend' option is available only in 'Multipoint' and 'Static' measurement modes.



Note



'Laser end' is displayed when the laser falls outside of the linearized range of the detector.

1. When measuring and 'Laser end' message appears, rotate the shafts backwards until the laser beam reenters the measurement range. The message 'Laser OK' reappears on the display. Press Menu . The context menu shown next appears.

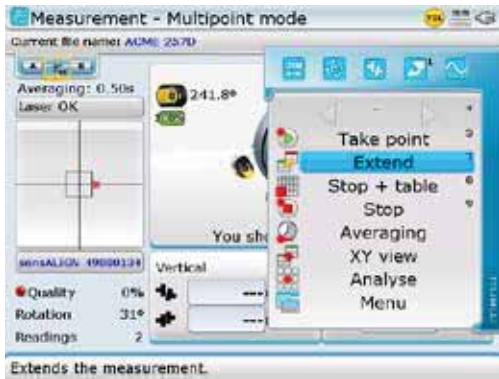

- Use \triangle / ∇ to highlight 'Extend', then press Enter . The program holds up measurement and switches to 'XY View' in the "Extend" screen. The current beam position is automatically taken as the starting point for range extension.

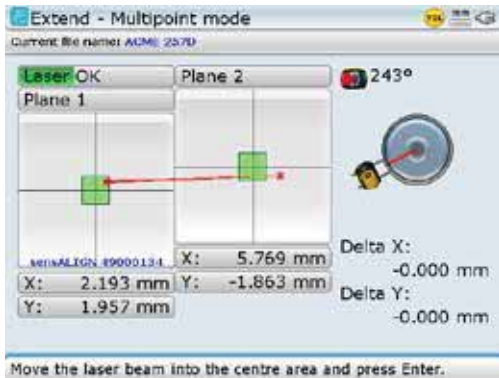

- Readjust the beam into the target squares using the two yellow sensALIGN laser horizontal and vertical position thumbwheels then press Enter or t . The adjusted beam position is taken as the end point of displacement.
- Continue measurement as before, rotating the shafts and pressing Enter to take measurement at the desired positions. ROTALIGN Ultra iS Shaft program includes the displacement of beam readjustment in the alignment calculations.

5.2.7 IntelliEXTEND

This feature automatically activates the extension of the measurement range while in IntelliSWEEP measurement mode. This range extension allows the adjustment of the laser beam such that it does not miss the detector surface when measuring shafts with gross misalignment or small angular misalignment over large distances. This feature is available only in the Advanced and Expert ROTALIGN Ultra iS Shaft levels.

Note that 'IntelliEXTEND' is available in Advanced and Expert Shaft levels only.



IntelliEXTEND is available only in 'IntelliSWEEP' measurement mode.



Note

1. When taking measurement using IntelliSWEEP and the laser beam approaches the end of the detector surface, a hint automatically appears on the display.



2. When the hint appears, use   to highlight 'Yes' the confirm selection by pressing .



3. Follow the hints on the display and center the laser beam using the yellow beam position thumbwheels.

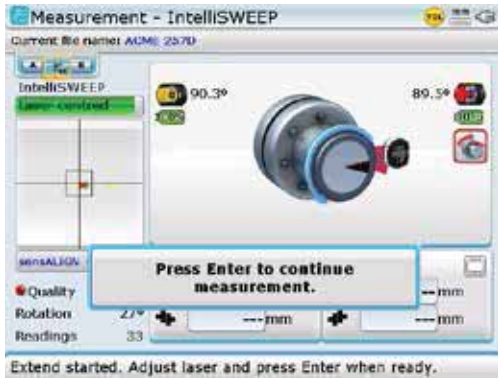

4. With the laser beam centered, press  then continue to rotate shafts to carry on with measurement.

5.2.8 XY View

The XY View function is used to facilitate the centering of the laser beam on the two sensALIGN sensor detector planes before proceeding with measurement. If the angular and offset displacement of the laser beam causes the laser beam not to strike both detector surfaces, the XY View function may be used to correct the deviation. As laser beam adjustment takes place in the “Measurement” screen, press  while on this screen, then use the navigation keys and highlight the submenu item ‘XY View’.



Note that the context menu item ‘Averaging’ is present when the measurement mode is either Multipoint or Static measurement.

Confirm selection by pressing . The two sensor detector planes are displayed on the “XY View” screen. Center the laser beam dots in both planes using both beam position thumbwheels. In some cases it may be necessary to move sensALIGN sensor along the support posts or sideways by loosening the chain type bracket and slightly rotating it.



The “XY View” screen displays an on-screen delta angle indicator which shows the angular position difference between sensALIGN sensor and sensALIGN laser. This aids the laser set-up procedure.

- 1 sensALIGN sensor angular position
 - 2 sensALIGN laser angular position
 - 3 Delta angle value $1 - 2 = 3$
 - 4 Delta angle on-screen indicator – the laser beam should be adjusted such that the needle rests preferably in the middle of the green sector.
- The delta angle feature is available in Advanced and Expert Shaft levels only.

The “XY View” screen context menu items include: ‘Sensor selection’, ‘Averaging’, ‘Trace on’, ‘Set to zero’/‘Set to absolute’, ‘Sensor version check’, ‘Laser version check’ and ‘Upgrade firmware’.



With the ‘Set to zero’ button highlighted, pressing  toggles between the 0,0 values and the absolute values.

Note that the measurement sensor and averaging may also be set on this screen.

‘Set to zero’ button

Trace on literally traces a path showing the laser dot movement on both planes.

Set to zero / Set to absolute toggles X,Y values of the laser beam dot on both planes between 0,0 and the absolute values. The laser beam dot positions may be set to 0,0 to act as a reference.

Sensor version check is active when the sensor is on and initialized. It is used to display the sensor firmware version.

Laser version check is active only when the laser is on and initialized. It is used to display the laser firmware version.

Upgrade firmware is used to start the built-in sensor and laser firmware update wizard.

If a sensor or laser with an older firmware version is connected to a ROTALIGN Ultra iS computer running on the current ROTALIGN Ultra firmware version, a hint to update the respective firmware appears on the display. The laser/sensor update wizard may then be prompted.

The sensALIGN sensor and laser firmware updates must be carried out only using the supplied sensALIGN sensor and laser cable ALI 4.921-2.



5.2.9 Intelli laser position

This Advanced Shaft feature is used to adjust the laser beam so that it remains in the sensor detector surface through the entire rotation of the shafts. This feature is useful when measuring shafts with gross misalignment or angular misalignment over large distances.

Intelli laser position is used as follows.

1. As laser beam adjustment takes place in the "Measurement" screen, press **Menu** while on this screen, then use the navigation keys and highlight the submenu item 'Intelli laser position'.



110

2. With 'Intelli laser position' highlighted, press **Enter** to confirm selection. A hint to rotate the shafts through 90° appears on the screen.



3. Rotate the shafts through at least 90°, indicated by the rotational arc turning green, then press .



In this example, the rotational arc is green indicating that the rotation is $\geq 90^\circ$. For this case, the advice to adjust the laser before proceeding with measurement appears on the screen.

4. After completion, an instruction on any further laser adjustment appears on the screen, including a blue dot which indicates the position to where the laser dot should be adjusted.



The blue dot shows the position to where the laser beam dot is to be adjusted. The laser beam dot is no longer adjusted to the center, but use is made of the entire detector surface.

5. After using the Intelli laser position, the "Measurement" screen submenu item 'Position to center' is now active. This is the default laser beam adjustment procedure but it becomes inactive when Intelli laser position is activated and used.



This screen further reveals that the 'Position to center' submenu item is now active and may be selected.

5.2.10 Half function

There are specific shaft alignment applications where the 'half function' is used to help ensure that the laser beam does not deviate away from the sensor detector during shaft rotation. The measuring of long spacer shafts is one such example.

The 'half function' procedure would be as follows.

1. As laser beam adjustment takes place in the "Measurement" screen, press  while on this screen, then use the navigation keys and highlight the submenu item 'Half function'.



2. Press  to confirm selection. The "Half function" screen opens displaying the absolute X,Y values of the laser beam on the detector.

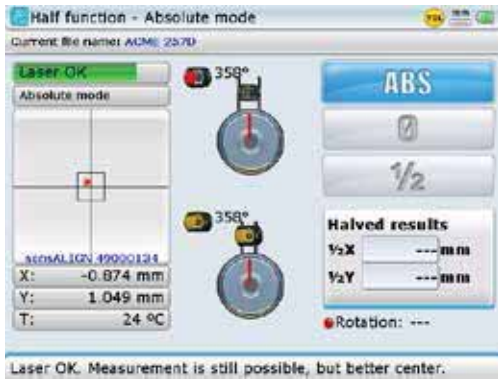

- Use the navigation keys and highlight the '0' half function icon then press  to confirm selection. The current laser dot position assumes the X,Y value 0,0.

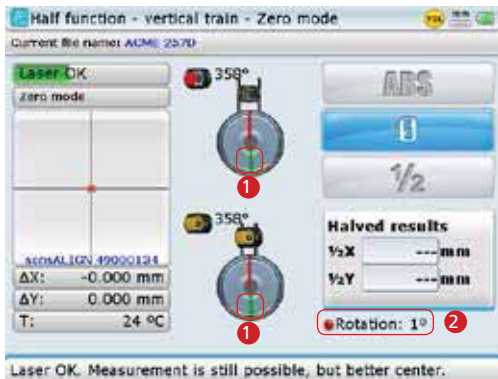

Note that the position to where the sensor and laser should be rotated, is marked green [1]. Rotation is carried out in any direction - clockwise or anti-clockwise [counterclockwise]. Also note the rotation angle and its corresponding button [2].

- Now rotate the sensor through 180° as indicated on the screen.



Note that the sensor rotation angle button turns green when the sensor rotation is at 178° to 182°.

- Use the navigation keys and highlight the '1/2' half function icon, then press  to confirm selection.

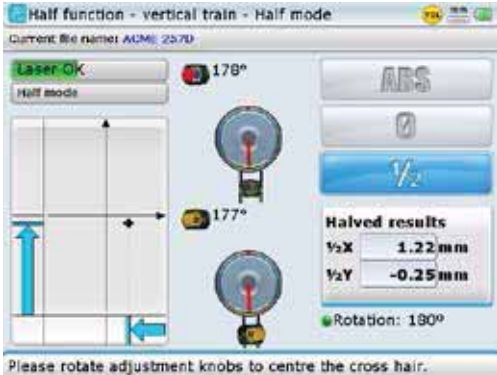

Note that the documented 1/2 X and 1/2 Y values correspond to half the ΔX and ΔY values recorded previously.

- Now use the two yellow sensALIGN laser beam position thumbwheels to position the cross hair at the centre of the two axes. The displayed 1/2 X and 1/2 Y results should be as near 0.0 as possible



- After attaining the required 1/2X and 1/2Y values [as near 0.0 mm as possible], the laser is now on the shaft axis. Press  to proceed with actual shaft alignment measurements.

5.2.10 Averaging

In certain industrial conditions, it may be necessary to increase the number of measurements (recorded laser pulses) to be averaged when taking readings to attain the desired accuracy. Particular cases include environments with increased machinery vibration. An increased averaging also improves the accuracy when measuring sleeve bearings, white metal bearings and journal bearings.

Averaging is possible in 'point' measurements such as 'Multipoint' and 'Static mode'. The duration of the averaging of individual readings which form one measurement is selected from either the "Measurement screen" or the "Measurement mode" screen or via the "XY view" screen. The XY view screen is primarily for live Move and soft foot measurement.

When setting the duration of the averaging from the corresponding "Measurement" screen, press **Menu** then use **Δ**/**∇** to highlight the context menu item 'Averaging'. Press **Enter** to confirm selection then use **Δ**/**∇** to select the desired averaging duration. Press **Enter** to confirm duration.

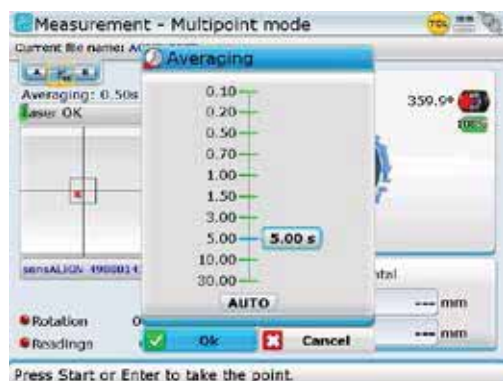

Setting averaging in the "Measurement" screen

In surroundings where environmental vibration is high, a higher averaging duration is recommended. ROTALIGN Ultra iS has the capability to set 'Auto' averaging. In 'Auto' averaging, the system records measurements automatically only when the readings are stable.

When setting the duration of the averaging while in the "Measurement mode" screen, use **Δ**/**∇** to highlight the desired 'point' measurement, then use **▷** to highlight the averaging duration drop down menu. Use **Δ**/**∇** to highlight desired averaging duration then confirm using **Enter** or **↵**.

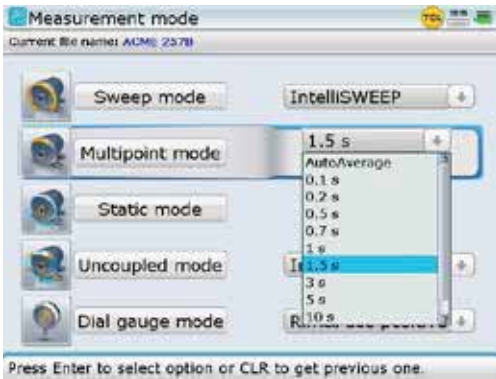

Setting averaging in the "Measurement mode" screen

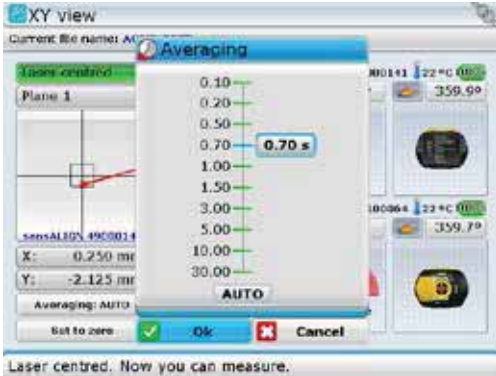

If averaging is set via the XY view, press Menu from the corresponding measurement screen and use the navigation keys to highlight 'XY view'. Press Enter to confirm selection. The XY view screen appears with the averaging box highlighted. Press Enter to expand the drop down menu, then use Δ / ∇ to select the desired averaging duration from the drop down menu.



Setting averaging in the "XY view" screen

Confirm value by pressing either Enter or L .

5.2.11 Measurements options screen

The "Measurement options" screen may be accessed via the "Measurement" screen context menu item 'Measurement options'. The context menu opens by pressing  while in the "Measurement" screen. Use / and highlight 'Measurement options'.



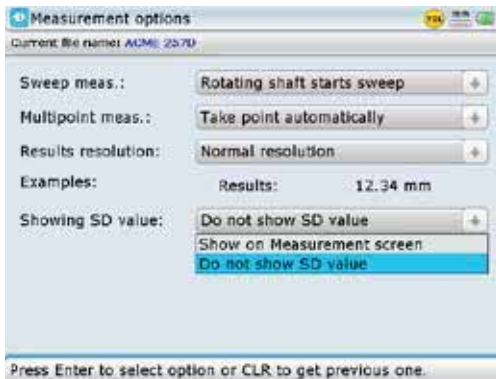

With 'Measurement options' highlighted, press  to confirm selection.



Alternatively, access the "Measurement options" screen directly using the global menu. Press  twice to open the global menu, then select 'Measurement' -> 'Measurement options'.



The "Measurement options" screen may be used to set the following selections:

- › Whether **Sweep measurement mode** is started manually [by pressing ] or automatically when shafts are rotated
- › Whether measurement points are taken manually [by pressing ] or automatically in **Multipoint measurement mode** – automatic collection of measurement points is based on stability filter parameters and may be used in Multipoint, IntelliPOINT and cardan shaft measurements
- › Whether results resolution is set to two or three decimal places
- › Whether the standard deviation is displayed on the screen or not

5.3 Measuring vibration

Using sensALIGN sensor only, it is now possible to measure any vibration that may influence the alignment results. The vibration may be inherent in the machine train or a result of external influence.

To measure the vibration, use is made of the "Measurement" screen submenu item 'Vibration measurement'.

With sensALIGN sensor switched on and mounted on the machine, press  to access the "Measurement" screen. Press  to display the context menu items. Use the navigation keys and highlight 'Analyze' -> 'Vibration meas.'.

The vibration measurement feature is available in Advanced and Expert Shaft levels only.

Note that for vibration measurement, use may be made of the vibration check probe ALI 4.905.

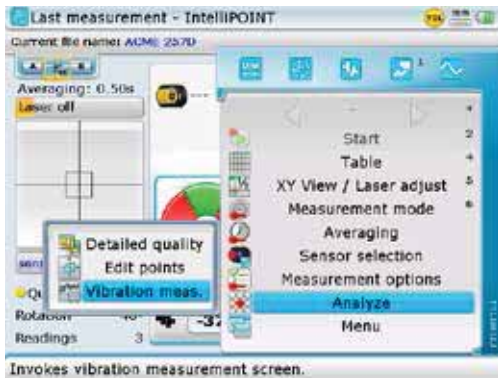

The submenu item 'Vibration meas.' is selected by first highlighting the context menu item 'Analyze'.

Press  to confirm selection. The "Vibration measurement" screen opens.

118



With the 'Start' button highlighted, press  to begin the vibration measurement.



As soon as measurement is completed, the vibration velocity measured in mm/s (or in/s) is displayed.

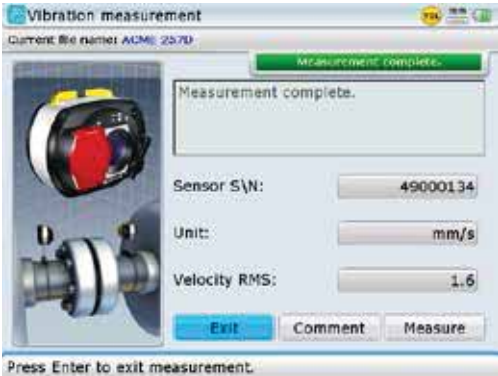

When measurement has been completed, the “Vibration measurement” screen provides options to exit the measurement, describe the measurement and to carry out additional measurements.

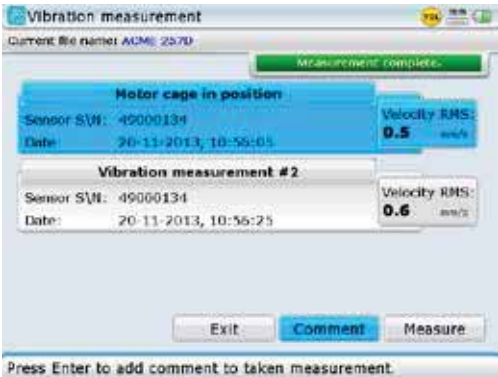

In this example, the 'Comment' button has been used to enter the description 'Motor cage in position'. The 'Measure' button is used to carry out any additional vibration measurement.

The three buttons are also available as context menu items in the “Vibration measurement” screen.



In addition to the three button functions, the context menu items also include the item 'Delete' which may be used to delete any unwanted vibration measurement.

5.3.1 Using the vibration check probe

The above vibration velocity measurement may also be carried out using the vibration check probe ALI 4.905.

Insert the probe in the sensALIGN sensor hole with a countersink such that the black base of the probe tip rests firmly on the sensor housing. Use the clamping lever to lock in the probe.

With the probe securely locked in, hold the probe firmly against the appropriate measurement location on the machine until measurement is completed.

sensALIGN sensor

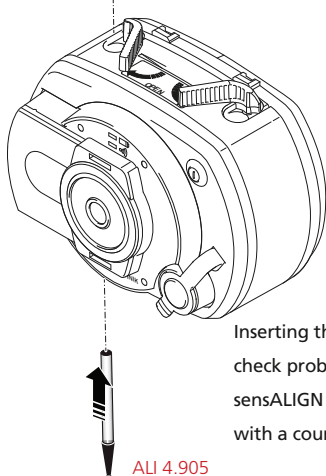

ALI 4.905

Inserting the vibration check probe in the sensALIGN sensor hole with a countersink

The sinusoid symbol indicates the sensALIGN sensor hole where the vibration check probe is to be inserted.

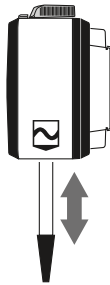

sensALIGN sensor

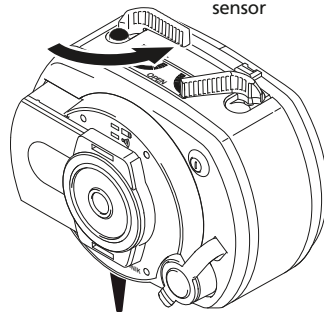

With the probe fully inserted and resting on the housing, push the clamping lever to the 'locked' position.



Exercise CAUTION when carrying out vibration measurement using the vibration check probe.



Transferring vibration measurement results via Bluetooth to ROTALIGN Ultra iS computer.

Page intentionally left blank

5.4 Set-up options

5.4.1 Machine type and fixation

ROTALIGN Ultra iS Shaft provides the user with a feature to designate the type and fixation for both left and right machines.

Please refer to “Machine properties in section 4.8

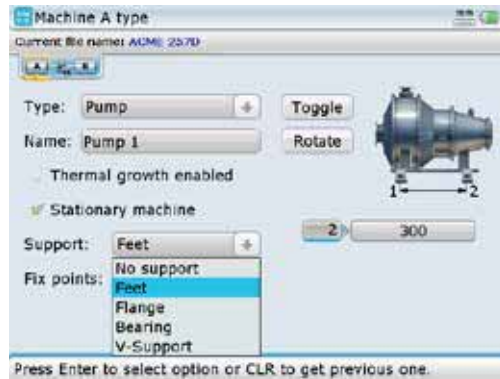

Use the navigation keys to highlight machine item boxes. Press  to either check selected item box or prompt the corresponding drop down menu.

5.4.2 Machine mounting

Detailed machine mounting can be specified in set-up.

In the set-up screen that follows, machine mounting has been defined as 6 feet (3 pairs of feet), has a V-foundation and is moveable.

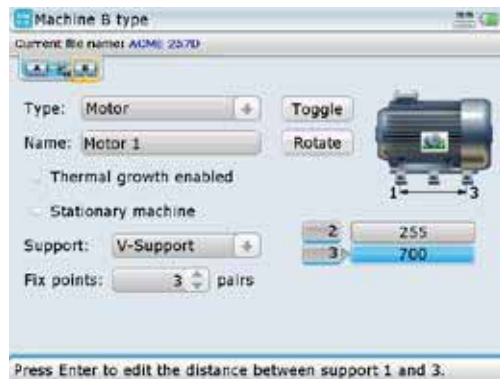

For machines with V-shaped supports, the angle between support surfaces and foundation must be entered in order to calculate corrections.

The respective angles are entered as follows:

- › From the dimension screen, use the navigation keys to highlight either of the support angle boxes (left side or right side). Note that the default angle is 45°, and a 0° angle indicates that the machine feet are parallel to the foundation, while a 90° angle indicates that the feet are perpendicular to the foundation.

Note that the support angle can be entered only on a 2-D dimensions screen.

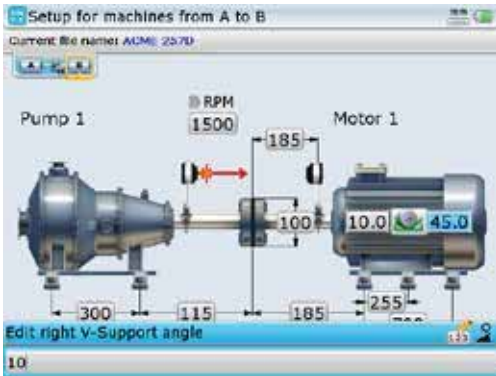

Dimensions screen in 2-D mode

The support angle θ is given as: $0^\circ < \theta < 90^\circ$

- › Use the data entry keys to enter the support angle for the selected feet position, confirming entry by pressing either Enter or t .
- › Select next position using the navigation keys and enter the support angle as described above.

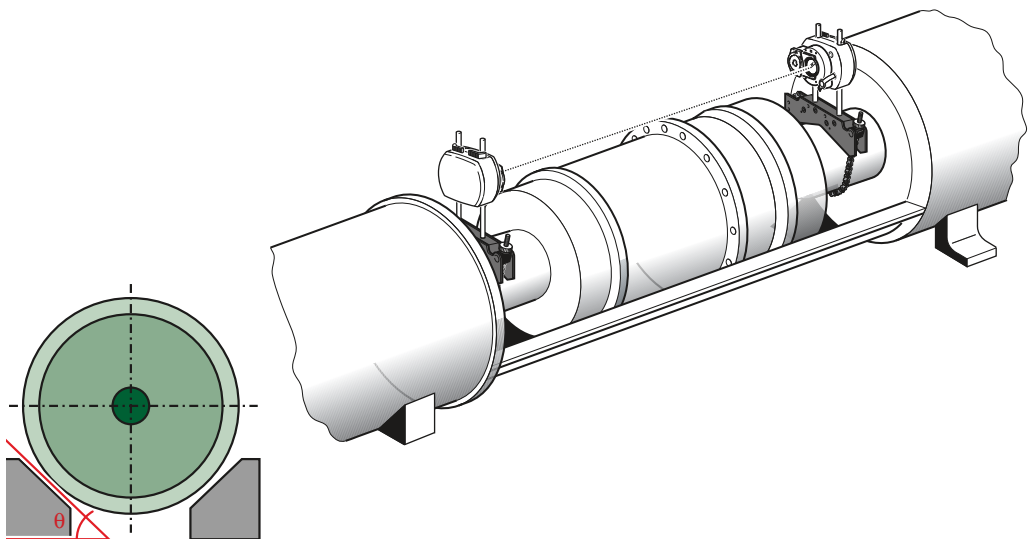

All alignment corrections are achieved solely by inserting and removing the proper combination of shims; corrections are indicated for each individual machine foot to yield the required horizontal and vertical displacement for the machine upon angled supports. These corrections correspond to the values in the results screen as shown below.

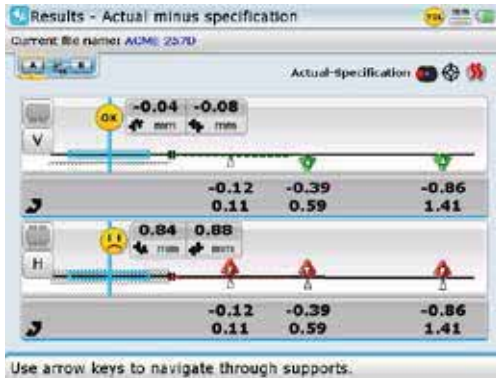

The vertical corrective values for each foot are shown below.

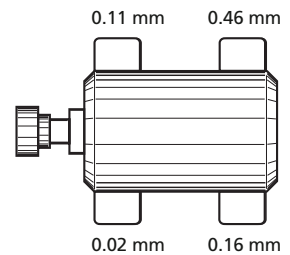

5.4.3 Coupling type

The following coupling types are available for selection:

- ▶ **Short flex** – These couplings feature fitted transmission elements with play (such as teeth, claws or bolts) or elastic connecting elements like rubber ‘tires’ or springs.
- ▶ **Single plane** – The coupling halves are bolted directly together. Loosen the bolts before taking measurements, since they would otherwise distort the true alignment condition.
- ▶ **Spacer shaft**: When the coupling halves are joined by a spacer element, its length must be entered.
- ▶ **Cardan shaft**: Just as with regular spacer shafts, the shaft axial distance (between coupling planes) must be entered.

5.4.4 Coupling results format

This parameter allows the desired display format to be selected for depicting the coupling alignment condition. This allows direct comparison with the manufacturer’s alignment tolerances. The proper format setting depends upon the coupling type used.

5.4.4i Short flex



Short flex is for most common types of “compact” flexible coupling. Coupling results may be displayed either as ‘Angle/Offset’ or ‘Gap/Offset’.

5.4.4ii Single plane



Single plane is for simple non-flexible couplings which are usually just two flanges bolted together. Coupling results may be displayed either as ‘Angle’ or ‘Gap’.

126

5.4.4iii Cardan shafts

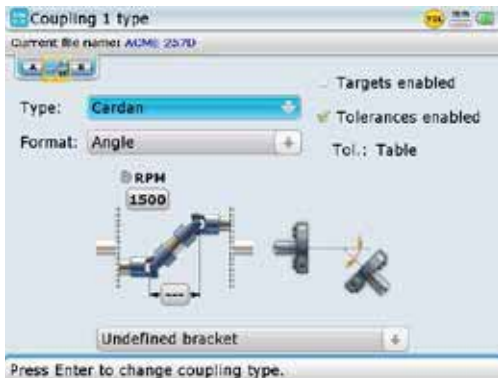

Cardan is for couplings with large offsets joined together by a spacer shaft and universal joints. Results are displayed in cardan angles.

5.4.4iv Spacer shaft

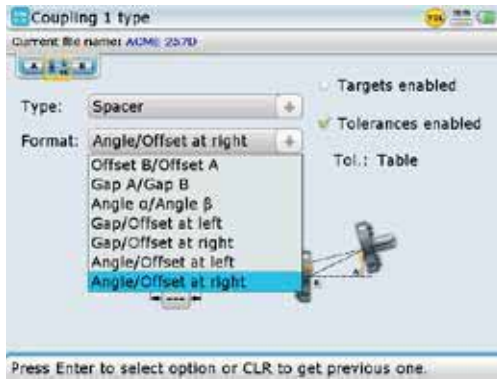

Spacer shaft is a coupling with two transmission planes and a spacer. Coupling results may be displayed in any one of the following formats:

- 'Offset B/Offset A
- 'Gap A/Gap B'
- 'Angle α /Angle β '
- 'Gap/Offset at left'
- 'Gap/Offset at right'
- 'Angle/Offset at left'
- 'Angle/Offset at right'

5.4.5 Sign convention

- ▶ Vertical alignment plane:
 - › Offset is positive when the right shaft centerline is higher than the left centerline.
 - › Gap and angularity are positive when the coupling opens toward the top.
- ▶ Horizontal alignment plane:
 - › Offset is positive when the right axis is further away from the viewer than the left axis.
 - › Gap and angularity are positive when the coupling opens away from the viewer.

5.4.6 Coupling targets

The position of machines at rest can be considerably different than that during operation (e.g. due to thermal growth or load-related displacements). This effect can be compensated through use of alignment target values for the coupling, which allow precise 'misalignment' when the machines are at rest so that they will be in proper alignment position during operation.

Alignment target values may be found in the machine documentation or upon request from the manufacturer or can be measured using the Live Trend Application or PERMALIGN. For further details, contact your local PRÜFTECHNIK representative.



The coupling type determines the targets to be entered. These values are entered as described in section 4.9 – 'Coupling properties'.

5.4.7 Tolerances

Alignment quality is evaluated through comparison with tolerances based upon entered machine dimensions and RPM.

The tolerance ranges are compiled as tables according to coupling type and diameter (for the gap value) as well as RPM. When the coupling type is spacer, the tolerance table values are determined by the length of the spacer shaft and the RPM. (See suggested shaft alignment tolerances within the 'Appendix'.)

In ROTALIGN Ultra iS Shaft the 'live' tolerance function can be activated or deactivated from either the coupling properties window or the tolerances window. When the function is checked active, the alignment quality is indicated with the 'smiley' symbol. Tolerance tables are viewed as follows:

Access coupling properties as described in section 4.9 – 'Coupling properties'.
 Press . The context menu appears. Use / to select 'Tolerance'.



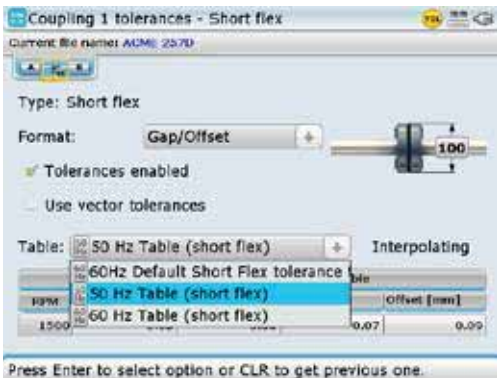

128

Press  to confirm selection. The tolerances screen appears.



Use the navigation keys to cycle through the screen elements. You may use the 'Table' drop down menu to set the appropriate machine operating frequency (either 50 Hz or 60 Hz).

The machine RPM may also be edited on the tolerances screen. Use the navigation keys to highlight the RPM value box then use the data entry keys to enter the desired value. Confirm entry by pressing either  or .

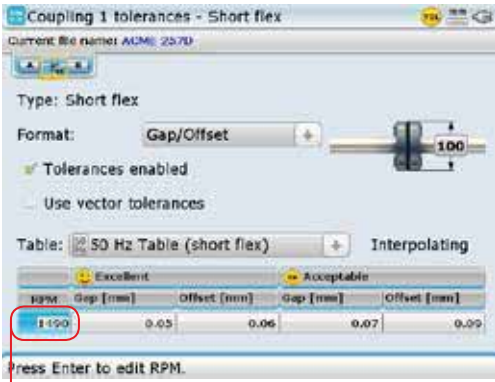



Alignment tolerances are divided into two quality ranges - 'acceptable' values are relatively generous and intended for noncritical machines and RPM ranges; 'excellent' values are intended for machines and RPM ranges that require especially accurate shaft alignment.

RPM value box

The given alignment tolerances are based upon standard industry norms and must not be exceeded, and they are to be used only if existing in-house standards or the machine or coupling manufacturer has not given any binding values.



If user defined tolerances are desired, use the coupling tolerances screen context menu item 'User tolerances'. Use  /  and highlight 'User tolerances'.

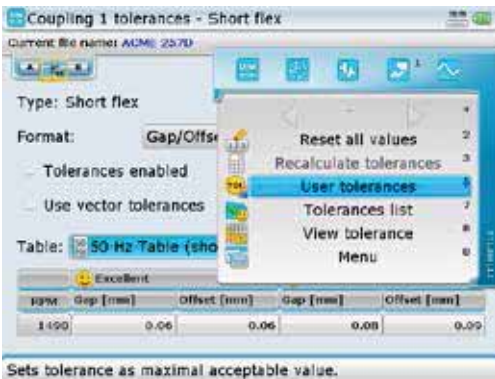

The context menu displayed in this example appears only when the system tolerance table is active.

With 'User tolerances' highlighted, press  to access the coupling tolerance screen used to edit tolerance values.

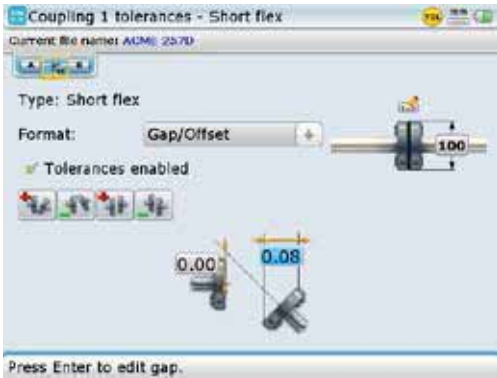

In this example, the user defined tolerances are symmetrical. In symmetrical tolerances, the tolerance values for both planes are the same.

Use the navigation keys to cycle through the value boxes, entering the tolerance values in the highlighted box using the data entry keys. Confirm entered value by pressing **Enter** or **↵**.

The context menu of the above coupling tolerances screen may be used to revert to the system tolerance table or define asymmetric (non-symmetrical) tolerances. The context menu is revealed by pressing **Menu**.



The context menu item 'Non-symmetrical' is used to define asymmetric tolerances. In asymmetric tolerances, the tolerance values for the two planes are not the same.

The context menu items are applied as follows:

- › 'Reset all values' – clears all entered tolerance values; if the coupling format and diameter had been changed in the "Coupling tolerances" screen, then the values revert to those entered in the dimensions (set-up) screen
- › 'Recalculate tolerances' – works out tolerances base on the coupling diameter entered in the dimensions (set-up) screen
- › 'Table' – toggles with the menu item 'User tolerances', and is used to activate the system tolerance table
- › 'Tolerances list' – used to display all available tolerance tables
- › 'Symmetrical' – toggles with the menu item 'Non-symmetrical', and is used to enter symmetrical tolerances

- › 'View tolerance' – used to show the complete tolerance table for the selected coupling type, and is active only when the system tolerance is activated

5.4.8 Thermal growth calculator



Machine conditions change from the time the machine is off line to when it is running under normal operating conditions. Some of these changes are due to process forces (e.g. fluid pressures, airflow). The most notable of these changes is the change in the temperature of the machine bearings and supports. This is called the machine's thermal growth.

ROTALIGN Ultra iS Shaft may be used to calculate thermal growth compensation if no other values are available. Thermal growth is calculated from the material characteristics, expected temperature difference and height of the shaft centerline above the shim plane.

Thermal growth is calculated as follows:



From machine set-up, use the navigation keys to highlight the machine whose thermal growth requires calculating.

With the machine highlighted, press  to access the machine properties screen.

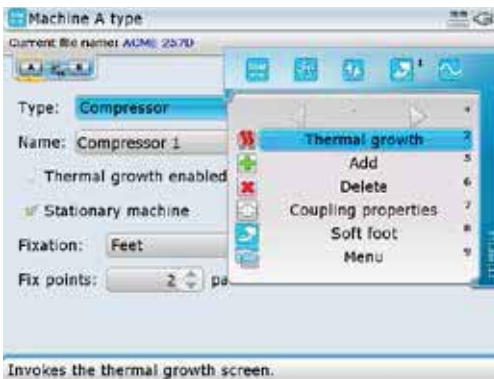
Press . The context menu appears. Use / to select 'Thermal growth'.



Press . The thermal growth screen appears.

Press . The context menu appears. Use / to select 'Thermal calculator'.



Press  to access the thermal calculator screen.

Proceed to select type of material using the drop down menu.

Use the navigation keys to highlight the respective value boxes and enter directly, the ambient temperature, the machine running temperature and the distance from machine base (or shimming plane) to the shaft centerline using the data entry keys.



The context menu item 'Add new value' is used when a machine is constructed of materials with different coefficients of thermal expansion. The context menu item 'Next' may be used to move cursor to the next machine foot pair.

5.5 Soft foot

Soft foot is the condition of machine frame distortion. Any cause that results in machine frame distortion when the machine is anchored to its foundation is a soft foot. Some principal causes are:

- › Non-coplanar machine mounting surfaces,
- › Deformed machine frame or feet,
- › External forces e.g. from connecting pipe or bracket,
- › Improper shimming or dirty machine feet.
- › Too many shims under a machine foot (a maximum of 3 should be used)

The consequences of forcibly tightening down the feet are deformed machine frames, bent shafts and distorted bearings. This leads to high vibration and premature failure.

Soft foot should be checked before aligning the shafts, and this can be done quickly and conveniently with the aid of the ROTALIGN Ultra iS Shaft soft foot function. With the sensALIGN laser and sensor mounted on the shaft in the usual way, the system is able to sense any machine movement when the machine bolts are loosened individually. By entering the machine dimensions, the computer is able to calculate, from shaft movement, by how much each foot has moved as it is loosened.

Once foot movements have been established, the results are interpreted and translated into shim thicknesses to be placed under the feet. How straightforward this is, depends on the type of soft foot present.

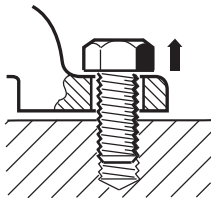

Parallel soft foot

One or more feet are too short or too long. This usually results in the machine rocking on the longer feet. This is corrected by shimming the shorter feet.

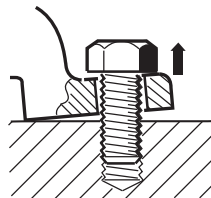

Angular soft foot

The base of the foot is at an angle to its foundation and they are only partly in contact. In this case, suspect foot is checked with a feeler gauge and corrected by building a custom 'shim wedge' or machining the underside of the foot

5.5.1 Checking and correcting soft foot conditions

The three main types are parallel soft foot, angular soft foot, and induced soft foot. There are instances where the soft foot is a combination of two or more types. Checking for soft foot is part of machine and job preparation.

The machine(s) to be measured should be treated first as normal four-foot machines. A machine with 6 or more feet is set up and measured like a four-footed machine (provided it is a compact rigid frame), with all the middle feet left loose, and after soft foot is corrected at the four main supports, the rest are feeler gauged and shimmed according to the feeler gauge readings or dial indicator readings on the foot itself.





Note

5.5.2 The measurement procedure

Soft foot may be measured from virtually any screen.



Note

1. Mount sensALIGN laser and the sensor in the normal way then carry out the laser beam adjustment (refer to section 4.11 – 'Laser beam adjustment').
2. With the lens aperture open, use the navigation keys to highlight machine whose feet are to be measured.
3. With the machine highlighted, press . The context menu appears. Use the navigation keys to highlight .

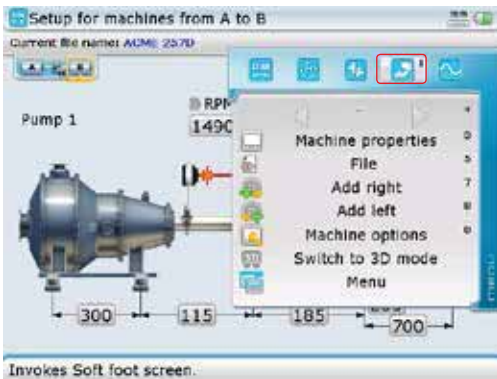

4. Press  to confirm selection.
If the laser is centered the following screen appears.



5. Press Enter to continue with soft foot measurement. [Proceed to step 9.]
 If however, the laser beam is not centered, press Menu . The context bar appears.
 Use Δ / ∇ and highlight 'XY view'.

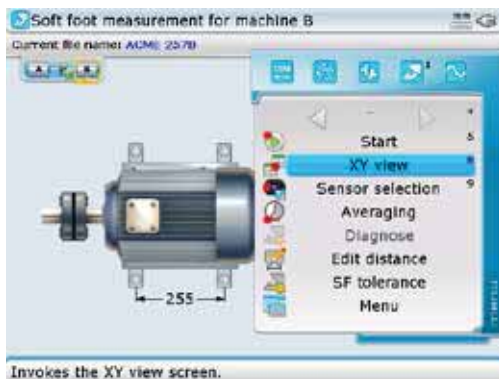

6. Press Enter to access the XY view screen.

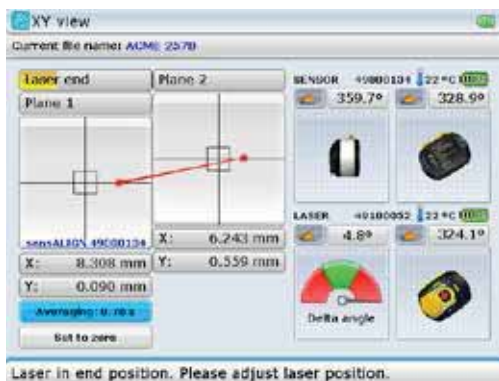

- Use the position thumbwheels to center the laser beam. Use the top thumbwheel to move the beam up/down. The side thumbwheel is used to move the beam sideways.

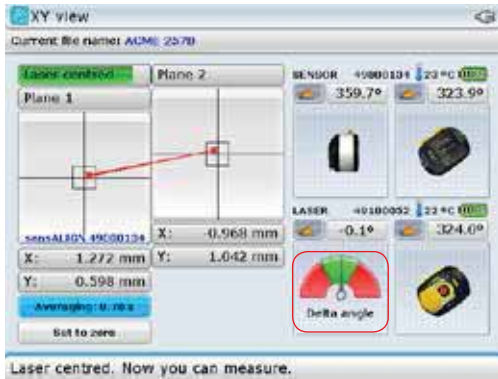

The laser beam should be adjusted such that the needle of the delta angle on-screen indicator rests preferably in the middle of the green sector.

- After centering the laser beam, press to return to the soft foot screen. Press to proceed with measurement.

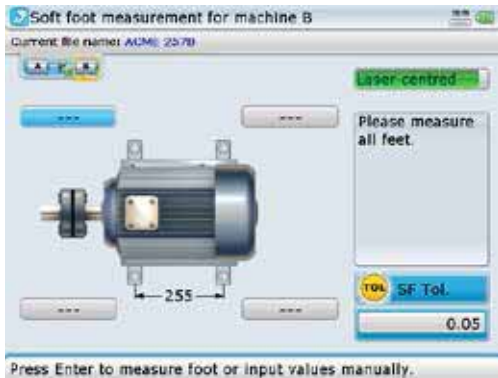

If machine dimensions have not been entered, pressing prompts the entering of the missing dimension. Before starting soft foot measurement, the "Soft foot measurement" screen context menu item 'SF tolerance' may be used to edit soft foot tolerance value (0.05 mm is the default value).

- With foot to be measured highlighted, press . A wrench (spanner) symbol appears on the screen. Loosen the corresponding foot bolt.

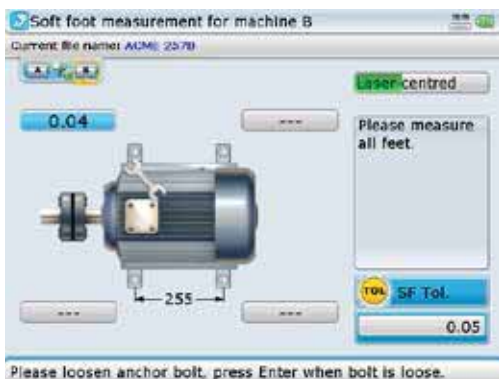

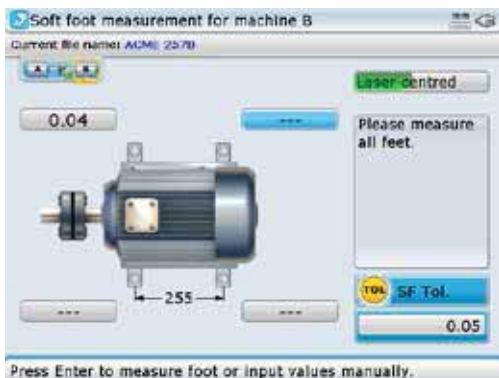

10. When the displayed value no longer rises, press  to save measured value. The wrench (spanner) symbol disappears and the highlight springs to the next empty value box. Tighten the bolt.

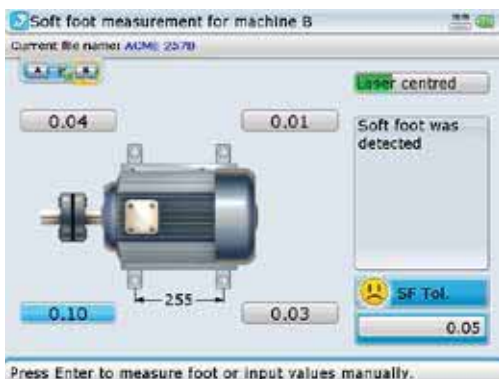
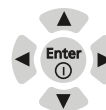

11. Repeat steps 9 and 10 for each machine foot. You may use the navigation keys to highlight any foot to measure.







In this example, soft foot has been detected and must be eliminated before proceeding with the alignment of the machines.

12. To investigate the soft foot, press . The context menu appears. Use / to highlight 'Diagnose'. ROTALIGN Ultra iS Shaft presents the user with concise instructions on how to eliminate the prevailing soft foot.

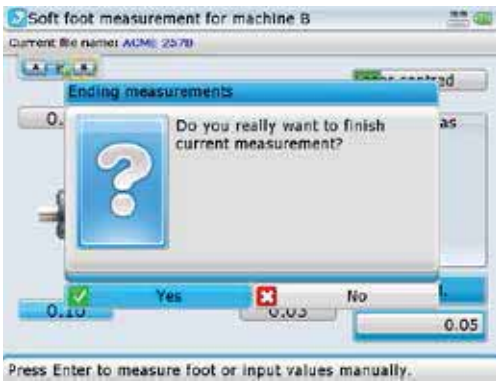

13. Press  to proceed. A hint appears requesting confirmation as to whether the soft foot measurement should be ended and diagnosis started.



14. Use / to highlight 'Yes' confirming selection by pressing , then proceed with diagnosis using the soft foot wizard.



The wizard offers the relevant remedy instructions for each different soft foot situation.

15. Follow the wizard instructions by highlighting 'Next' using the navigation keys then pressing  until the diagnosis and correction is completed.



The wizard screen indicates that squishy soft foot has been detected.

15. After correcting the soft foot, continue with alignment of the machines.

This page intentionally left blank



Chapter 6: Special alignment applications

This chapter deals with alignment of machines that require use of special procedures rather than those for the standard horizontal alignment. These special applications include:



- ▶ Machine trains (groups of up to 14 machines coupled together for Advanced/Expert Shaft levels, and groups of up to 6 machines coupled together for Standard Shaft level)
- ▶ Cardan drive machines (a more comprehensive guide to cardan shaft alignment may be found in 'Cardan shaft alignment getting started' DOC 99.201.en)
- ▶ Flanged machines (mounted vertically or horizontally)

6.1 Machine train alignment

6.1.1 Set-up

1. After starting the alignment application, either select a suitable template or configure the machines as appropriate.
2. To select a suitable template, press  while in the set-up screen. The context menu appears.
3. Use / to select 'File'/'New'.



4. Press . The "Open template" screen appears. Use / to select required template.

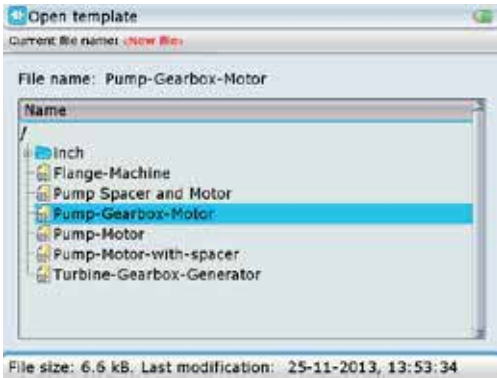

After highlighting the required template, confirm selection by pressing **Enter**.

- Multiple machine trains can also be configured from the set-up screen. Press **Menu**. The context menu appears. Use **△**/**▽** to highlight 'Add left' or 'Add right' depending on which end of the machine train a machine is to be added.



With the context menu displayed, pressing the corresponding data entry key performs the required action directly. For example, pressing **7pgs** adds a machine to the right end of the machine train.

After highlighting the required train end, confirm selection by pressing **Enter**.

- After either selecting an appropriate template or configuring the machine train, proceed to define the machines and enter the corresponding dimensions as detailed in section 4.7.

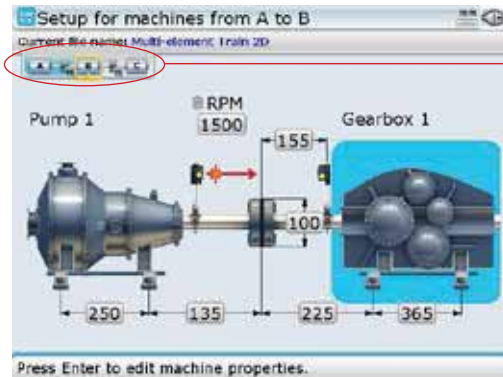

The yellow focus shows the machine train element on which the blue cursor is presently placed.

6.1.2 How to align machinery trains



The following step-by-step approach is recommended for multiple element trains.



1. Measure alignment at each coupling
2. Display results and optimize corrections (by defining 'stationary' machine feet)
3. Align the two machines at the first coupling position (remount sensors if necessary). The Live Move function is used to perform foot corrections.
4. Check alignment results
5. Align the two machines at the next coupling position, then repeat alignment check
6. Repeat step 5 until all machines have been aligned.

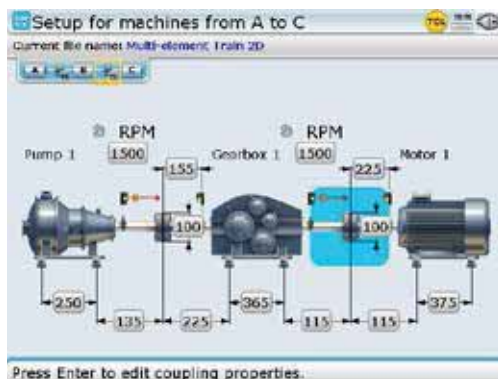

6.1.3 Measurement

1. While in the set-up screen, use  to zoom out the machine train. Pressing the key repeatedly will zoom out until the entire machine train fills the display screen.





To view any respective part of the train closely, highlight the section using   then zoom in by pressing .

A machine train of up to a maximum of 14 machines (13 couplings) can be configured [Advanced / Expert Shaft]. You may view the entire machine train at once through the 'zoom out' function [, however, the maximum number of machines for which all dimensions can be viewed at one time is 5 machines (4 couplings) Simply use   to scroll through the machines in the train.



2. Use   to select the machine coupling to be measured first.
3. Ensure sensALIGN laser is mounted on the left side of the selected coupling.

4. Adjust the laser beam as described in section 4.11.
5. Press  then proceed to take measurement as described in section 4.12.





While in the measurement screen, you may jump to the desired coupling to be measured by pressing and holding  .

6. Press  to stop measurement.

If the measurement mode used is not IntelliSWEEP or Continuous Sweep, measurement is stopped by pressing  and then highlighting 'Stop', and confirming selection by pressing .



Note

7. Switch both sensALIGN laser and sensor off then dismount them from the presently measured coupling and mount them across the next coupling.
8. Press and hold   to move to the cursor to the next coupling to be measured. Observe the machine train inset at the left top corner of the display.

Please make sure when moving the laser and sensor to each coupling that the dimension from sensor to coupling center is entered correctly in the dimensions screen.

Always make sure the coupling you are measuring is the one actually highlighted in the machine train!



Note

9. Repeat the measurement procedure (steps 3 to 7) until measurements have been taken across all couplings.

6.1.4 Evaluating results

1. Press **RES** to view the alignment results at the individual couplings.

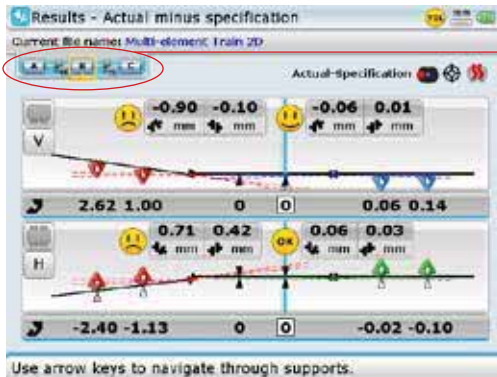

The yellow focus shows the machine train element on which the blue cursor is presently placed.

2. To view the results at the next coupling, simply press and hold down **←/→** to jump to the next coupling in the train. Alternatively, press **Menu** and use **△/▽** to highlight the direction arrow to the next coupling as shown in the next screen.

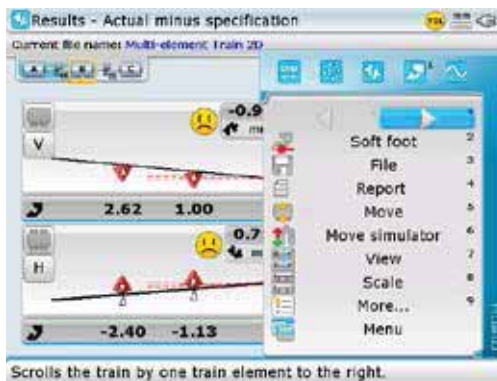

Pressing **Enter** with the 'right arrow' highlighted moves the display to the next coupling position on the right.

3. With the direction arrow highlighted, press **Enter** to view the alignment results at the next coupling position.

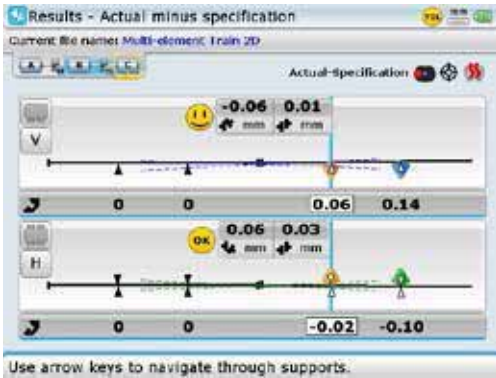

- To view the alignment results of the entire machine train, press Δ and hold to zoom out the train, or simply press RES .

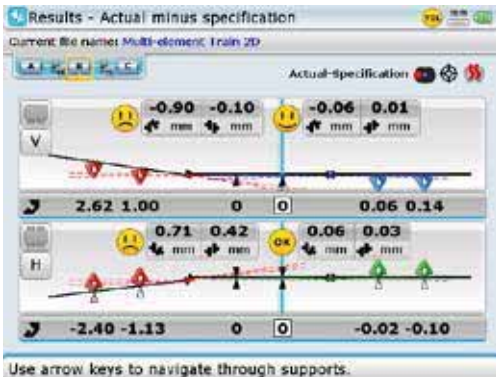

After deciding on which pair of machines to move in a train, you may need to reinstall and readjust the laser and sensor across the chosen coupling. Be sure to install the sensor at exactly the same location on the shaft or coupling as previously. If you discover later that you made a mistake, you can always correct the sensor-to-coupling dimension in the Measurement table individually for any alignment measurement or move, without affecting any of the other measurements or moves.

Note that multiple element trains may also be measured using the ROTALIGN Ultra iS Expert platform application Multiple coupling. For details on this application you may contact your local PRÜFTECHNIK Alignment sales partner.

6.2 Cardan shaft alignment

This section describes the alignment of cardan shafts using the cardan shaft bracket Lite ALI 2.874 SETIS in conjunction with ROTALIGN Ultra iS. Cardan drives are installed and operate with a large offset between the driver and the driven shaft. The spacer shaft is set at a minimum angle of usually 4° to 6° in order to ensure sufficient lubricant circulation, which in turn prevents the universal joints from seizing. Excessive misalignment of such a configuration leads to rapid fluctuation of the driven shaft RPM during operation, which holds grave consequences for electronically-controlled synchronous and asynchronous AC drive motors.

For smooth operation the machines should be aligned such that the driving and driven machine shaft centerlines are parallel. Precise alignment reduces the rotational irregularities of the cardan shaft to a minimum, so that the uneven bearing loading during cardan shaft rotation is also minimized, the service life of the components is extended and the chance of unexpected machine failure is reduced.

The measurement procedure described here allows precise measurement of machines joined by cardan shafts over distances of up to 3 m (10 ft) and shaft offsets of up to 400 mm (15 3/4 in.) using ROTALIGN Ultra iS.

ROALIGN Ultra iS Shaft provides five bracketing options with which cardan shafts may be measured. The measurement procedure used for these bracketing systems is detailed in the 'Cardan shaft alignment getting started' DOC 99.201.en. This handbook only describes measurement using the cardan shaft bracket Lite ALI 2.874 SETIS.

6.2.1 Mounting the faceplate to the rail

1. Slide the faceplate down the rail as shown in figure (1a) below. The four T-nuts should sit in the grooves.
2. After positioning the faceplate on the rail, tighten the four socket head screws using the provided M6 allen key (see figure 1b).
3. Mount the bracket assembly to the coupling face of the non-rotatable shaft. If the coupling face has a raised rim, the precision machined spacers are used as shown in order to separate the bracket faceplate from the raised inner section of the coupling face (see figure 1c).

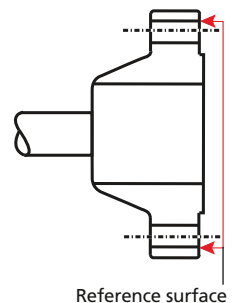

147

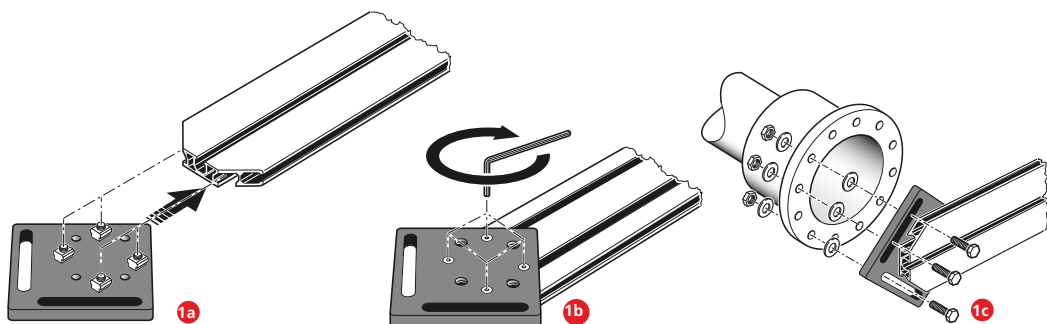

Without the spacers, there would be no direct contact between the faceplate and the coupling surface surrounding the bolt holes – exactly the location where the faceplate and coupling are being joined.



The centre part of the coupling face must not be used as a reference surface.

6.2.2 Mounting the laser holder assembly on to the rail

1. Loosen the handwheel slightly, then slide the laser holder assembly down the center groove of the rail, with the T-nut acting as a guide (see figure 2a).

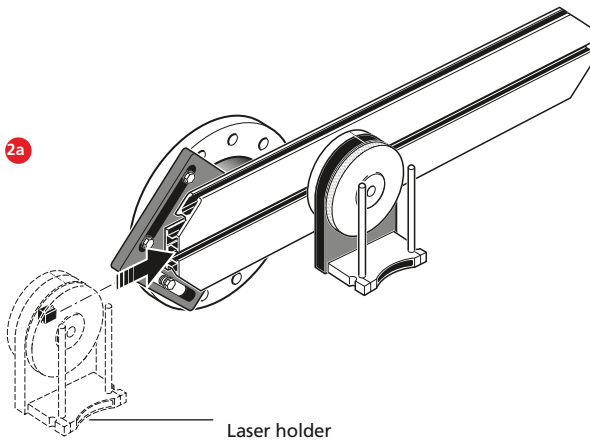

The coupling shown previously has a raised face flange. The provided spacers are used to create a three-point plane to ensure that the faceplate and the coupling face, which is the reference surface are joined together.

6.2.3 Mounting and adjusting sensALIGN laser

1. Slide the distance plate down the support posts.

Note that the distance plate is used to position the laser beam on the same axis as the rotational axis of the laser holder.

Prior to mounting sensALIGN laser, adjust the two yellow beam position thumbwheels to center the laser 'bulls-eye' as accurately as possible. This ensures that the laser beam is emitted as straight as possible.



'bulls-eye'

- Slide the laser onto the posts until it rests on the distance plate (refer to figure 3b).

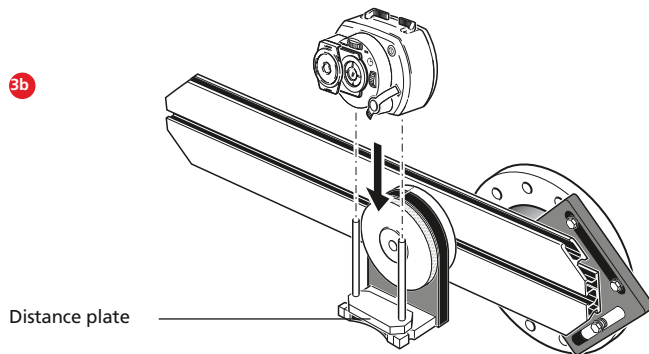

- Mark a set of target crosshairs on the shaft rotation centerline of the other machine coupling (if the flange has a center hole, a temporary target surface may be affixed to the hole).
- Switch sensALIGN laser on then adjust the beam to strike the center of the target on the opposite coupling:
 - › The objective is to adjust the laser beam such that it is roughly colinear to the rotational axis of the laser holder assembly; this will make it possible to make fine adjustments to the laser holder assembly's position afterwards, without having to realign the laser beam itself.
 - › The two yellow beam position thumbwheels are used to adjust the angular position of the laser beam. By rotating the laser assembly holder, the laser beam traces an 'approximate' circle. If the 'approximate' circle is a single dot at the center of the target, then the laser beam has been adjusted correctly. If that is not the case, repeat the laser beam adjustment process until the 'approximate' circle corresponds to a single dot position.

Laser adjustment tip

If the beam describes a circle rather than a dot at the target when rotating the laser holder assembly, then note how big the circle is and use the yellow adjustment thumbwheels to move the laser beam back by half the distance it has moved when rotating the laser holder assembly 180° from its start position. Do this both vertically and horizontally. When correctly adjusted, you should be able to rotate the laser holder assembly a full 360° without the laser dot moving from the target center (refer to figure 3c).



Note

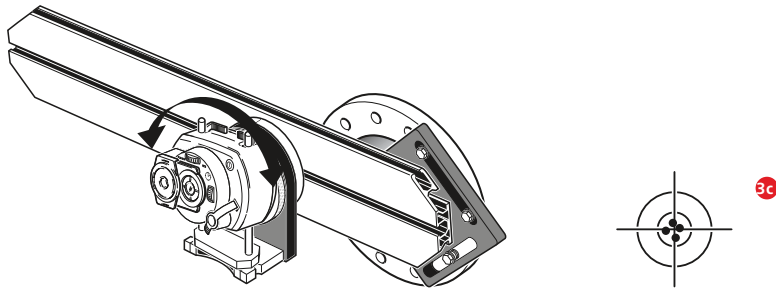

As soon as a single dot position has been achieved, do not touch the laser position thumbwheels.

6.2.4. Adjusting the laser beam to machine's rotational axis

In this step, the laser holder assembly is adjusted on the bracket such that the laser holder rotational axis is colinear with the rotational axis of machine to be aligned (which could be a motor or a gearbox).

During this procedure, DO NOT touch the yellow laser beam position thumbwheels.



1. Carry out the vertical and horizontal adjustment of the laser holder assembly by sliding it horizontally through the bracket rail and positioning it vertically by rotating the bracket.

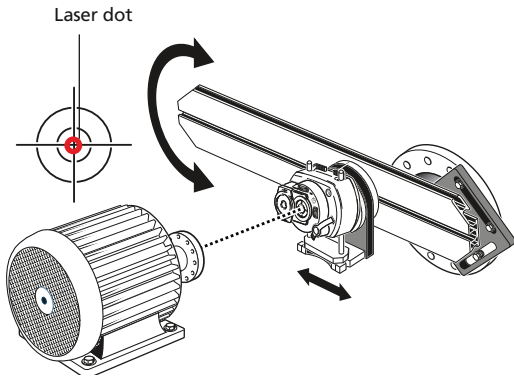

2. Repeat the above procedure until the laser beam strikes the center of the target placed on the rotational axis of machine to be aligned.
3. Once the laser beam has been centered on the target, tighten the faceplate on the coupling face using the provided hexagon socket head screws.

6.2.5 Positioning laser and mounting sensor for measurement

In this step, the laser is remounted on the underside of the laser holder while the sensor is mounted on the shaft of the machine to be aligned.

1. Switch off the laser and remove it from its holder.
2. Using the provided M4 Allen key, loosen the support posts then slide them through the laser holder base so that they protrude from the other side.

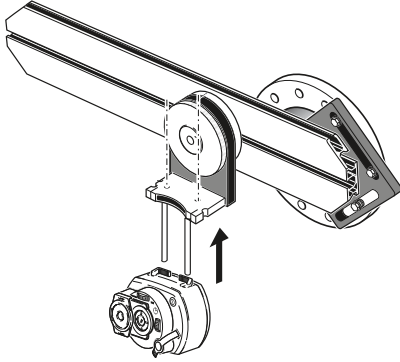

3. Retighten the M4 Allen screws to secure the support posts, then remount the laser onto the support posts.
4. Use the chain-type bracket or appropriate magnetic brackets to mount the sensor on the shaft of the machine to be moved (for instance the motor or gearbox). The sensor is aligned to the laser by pushing or sliding the bracket supporting the sensor.

Do not touch the laser or its laser position thumbwheels.



Note

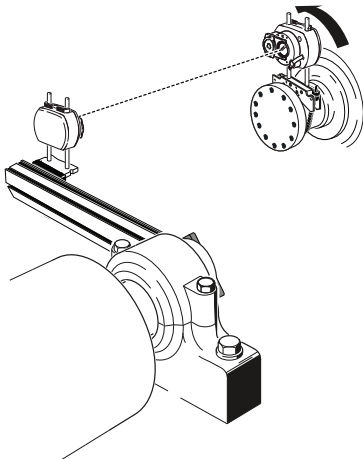

6.2.6 Set-up and measurement

1. With sensALIGN laser, sensor and ROTALIGN Ultra iS computer switched on, proceed to set up the machines (refer to sections 4.6 – 4.9). From the machine set-up screen, highlight the coupling, then press  to access the “Coupling type” screen.
2. Select the coupling type ‘Cardan’ then navigate to the bottom box to select type of bracket to be used from the drop down menu that opens.

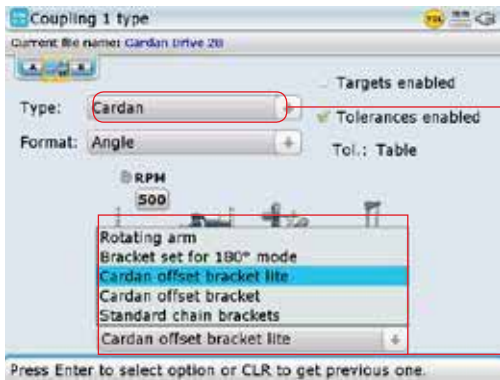

Selected coupling type

Bracket type drop down menu to select ‘Cardan offset bracket lite’

3. Use / and highlight ‘Cardan offset bracket lite’. This is the option for the cardan shaft bracket Lite ALI 2.874 SETIS.
4. Press  or  to confirm selection.
5. Slide the sensALIGN sensor dust cap to expose sensor lens then press . The laser beam location should be apparent in the “Measurement” screen, and the ‘Start’ button is automatically highlighted.



When using the cardan shaft alignment bracket Lite ALI 2.874 SETIS, the system selects the IntelliPOINT measurement mode.

To center the needle, both laser and sensor must be at the same rotational angle.

- 1 – Designated measurement mode for the cardan bracket Lite set ALI 2.874 SETIS with ROTALIGN Ultra iS Shaft Advanced
- 2 – On-screen needle indicator
- 3 – ‘Take point’ button’

Press Enter to take point.

6. With the laser beam centered, and the needle exactly at the center of the green sector, press Enter to take the first measurement.
7. Rotate sensALIGN sensor to the next measurement position.
8. Turn the laser-side shaft and observe the on-screen needle indicator. The 'Take point' button only appears when the needle is in the blue sector.



The 'Take point' button appears only when the laser beam strikes the sensor within the detector range, and the value stabilization time is attained.

9. Press Enter to take the next measurement.
10. Repeat steps 7–9 above, to take measurements in as many positions over as wide an angle as possible, ensuring that the measurement quality is acceptable.



11. When a good enough measurement quality has been attained, stop measurement using the "Measurement screen" context menu item 'Stop'.

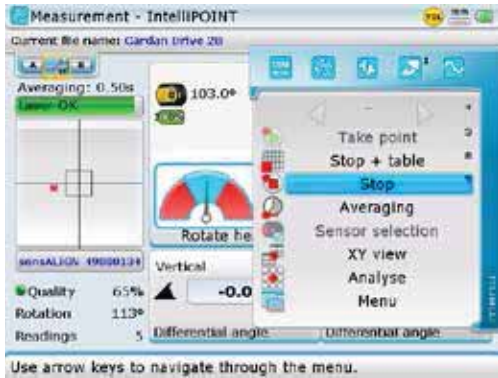

Stop measurement by using / to highlight 'Stop' then pressing to confirm selection.

6.2.7 Evaluation and alignment

Offset has no real influence in the alignment condition but any angularity at the rotational axes must be corrected.

1. Press to view alignment results.

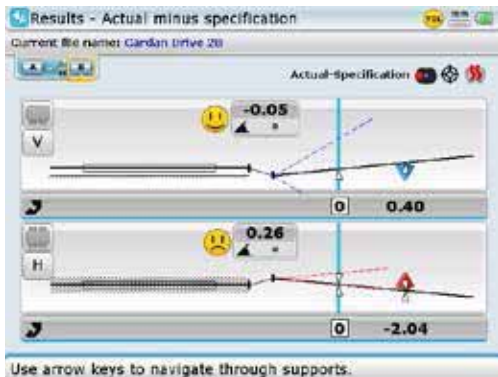

As only angularity must be corrected in cardan shaft alignment, results displayed show only foot values for one pair of feet.

Angularity may be presented in mrad or degrees. Cardan shaft units are set under 'Configuration' (refer to section 8.1.3).

A PRÜFTECHNIK cardan shaft tolerance table is available for 1/2° and 1/4° limits. The tolerance table is accessed via 'Coupling properties' (for details refer to section 4.9).



Note

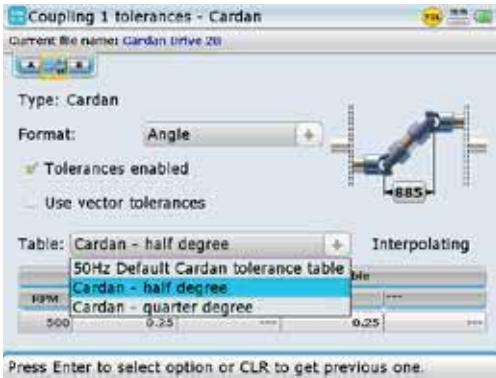

The tolerances table may also be accessed as described in section 5.4.7.

2. Out of tolerance machines may be repositioned with the help of the MOVE function (refer to section 4.13).
3. Remeasure to determine the new alignment condition by pressing , then repeating steps 9-11 in section 6.2.6.

6.3 Flanged machines

A typical vertical machine arrangement comprises one machine mounted on top of the other using a bolted flange.

Flange-mounted machines may have a vertical or horizontal orientation. In either case, alignment corrections are made directly at the flange.

Angularity is corrected by inserting or removing shims between the flanges. ROTALIGN Ultra iS calculates the shimming thickness for each flange bolt. Offset is corrected by positioning the flange laterally.

6.3.1 Overview - vertical machinery



Note

Before commencing with this section, please acquaint yourself with 'Horizontal shaft alignment' in chapter 4.

sensALIGN laser and sensor are mounted on either side of the coupling as for horizontal machines, with sensALIGN laser on the shaft of the machine designated stationary. The electronic inclinometer cannot determine the rotation angle of vertical shafts; therefore measurements must be taken on vertical machines using Static measurement mode. The eight 45° measurement positions used with this procedure must be marked accordingly on the machine.

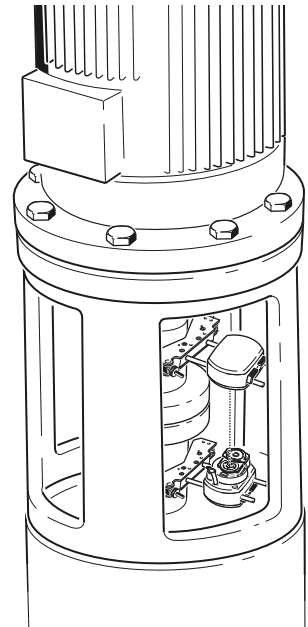

6.3.2 Marking measurement positions

1. Mark a reference position on the coupling housing close to the shaft and in line with a convenient external reference or flange bolt. Likewise, mark a reference point on the shaft.
2. Measure the circumference of the shaft and divide by eight.
3. Use this distance to make seven more evenly-spaced marks on the shaft beginning at your chosen start point. Number the points counterclockwise as seen from sensor to laser, beginning with 0 first, followed by 1:30, 3:00, 4:30, 6:00, 7:30, 9:00 and 10:30.

For circular housings, measure the circumference of the coupling housing and divide by eight. Use this distance to make eight evenly-spaced marks on the housing beginning at your chosen start point. Number the points clockwise looking down onto the shaft with 0 as the first, followed by 1:30, 3:00, 4:30, 6:00, 7:30, 9:00 and 10:30.

Evenly-spaced marks are made on the bearing housing beginning with 0 as the reference and numbered clockwise looking down onto the shaft.

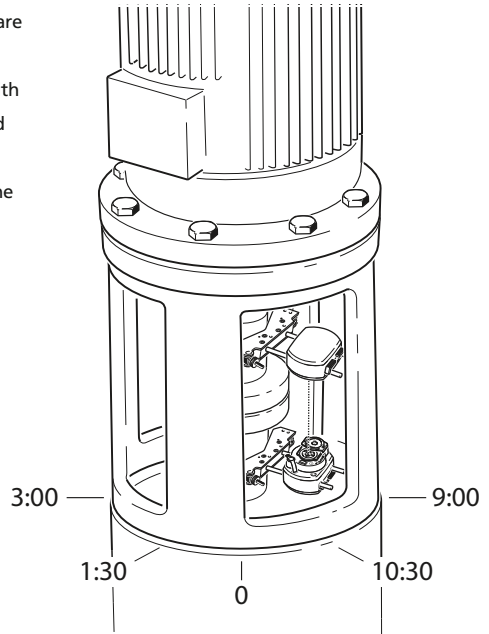
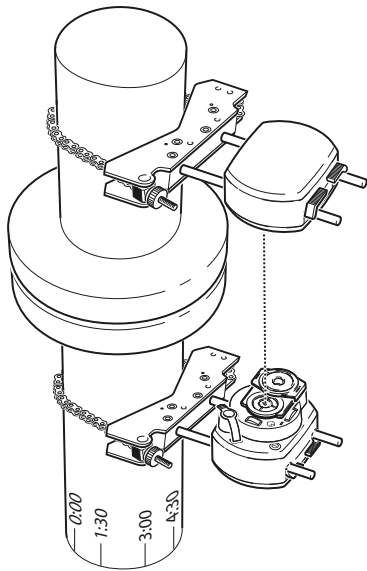

6.3.3 Set-up

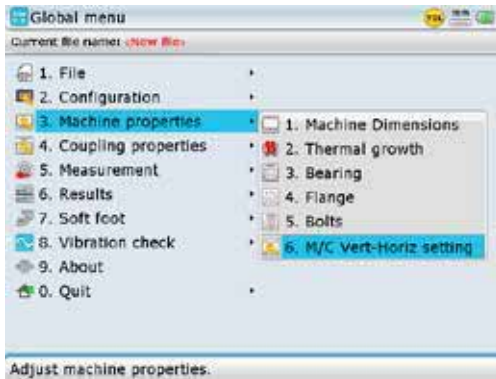

1. Mount sensALIGN laser and sensALIGN sensor on either side of the coupling, ensuring that they are aligned exactly with the 0 or reference mark.
2. Switch ROTALIGN Ultra iS on, then start the shaft alignment application. When the dimensions screen appears, press  twice to open the global menu.



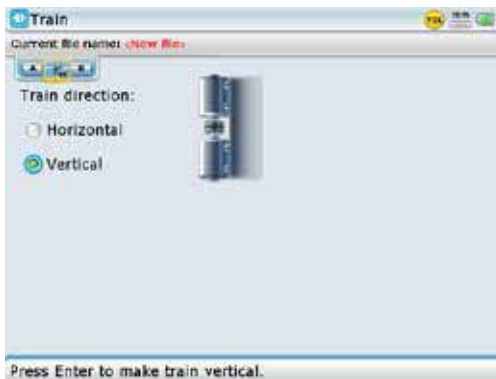

3. Use the navigation keys to select 'Machine properties' / 'Machine vertical-horizontal setting', confirming selection by pressing . The train orientation screen appears.



Use the navigation keys to select the train orientation 'Vertical'.

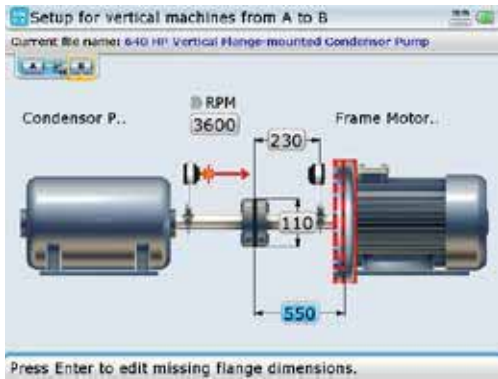

4. After selecting 'Vertical' train orientation, confirm selection by pressing . The confirmed machine orientation is depicted on the screen. Use  to return to the set-up screen.
5. Configure the machines as appropriate. (Refer to section 4.7.)

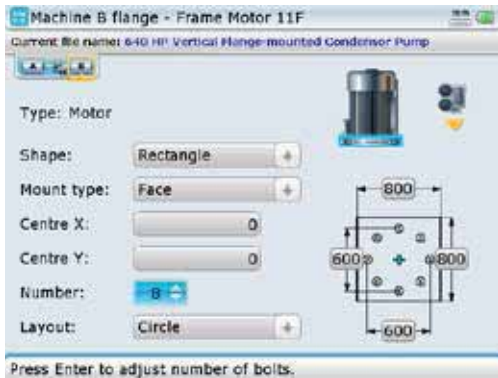

6. When entering machine dimensions, the flange geometry must be taken into account. Use the navigation keys to highlight the flange-mounted machine then press . A hint requesting the definition of the flange appears. Confirm by pressing . The flange editing screen shown next appears.



Details on how to navigate and edit items on this screen are discussed in section 4.8.

7. Use the navigation keys to cycle through the flange properties.
 - › The shape of the flange is selected from the 'Shape' drop down menu. Any one of the following shapes may be selected from the menu: 'Circle', 'Rectangle', 'Polygon'
 - › Flanges can either be face or reverse-mounted (see next illustration). The mounting is selected from the 'Mount type' drop down menu.
 - › The exact location of the center of the shafts is defined in the boxes 'Center X' and 'Center Y'
 - › The number of bolts is edited directly using the data entry keys or  / 
 - › The pattern formed by the bolts is selected from the 'Layout' drop down menu. The following bolt patterns are available: 'Circle', 'Rectangle', 'Polygon'
 - › The flange dimensions and bolt pattern lengths are entered directly using the data entry keys

An elliptical flange and bolt pattern may also be configured. Simply select a 'circle' flange shape and 'circle' bolt layout, then edit the flange length and width and bolt pattern length and width dimensions individually.

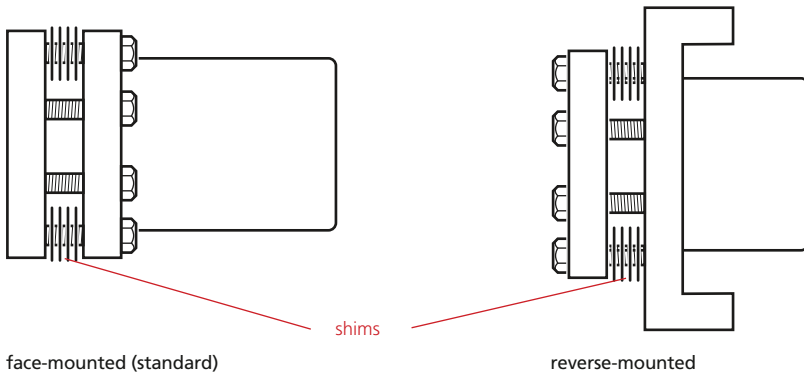

face-mounted (standard)

reverse-mounted

- It may be necessary to edit the bolt coordinates. To do this, press  while in the machine flange screen. The context menu appears.

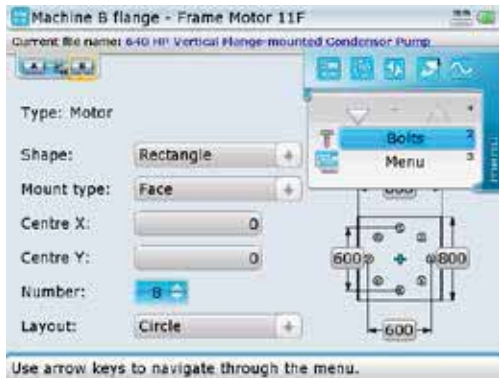

- Use the navigation keys to highlight 'Bolts' then press  to confirm selection. The bolt coordinates screen shown below opens. It shows the polar and Cartesian coordinates of the bolts relative to the chosen shaft center.

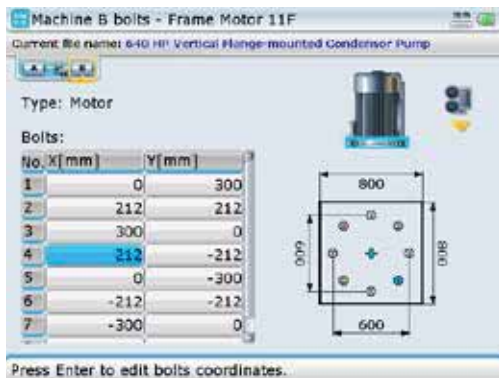

Use the navigation keys to highlight the XY coordinate of any bolt position. The highlighted value may be directly edited using the data entry keys.

In this example, the X-coordinate of bolt number 4 has been highlighted. The corresponding bolt pattern position also appears highlighted.

6.3.4 Measure

1. After entering the required dimensions, press  and proceed to center the laser beam.

For vertically oriented machine trains, static measurement mode is selected automatically.

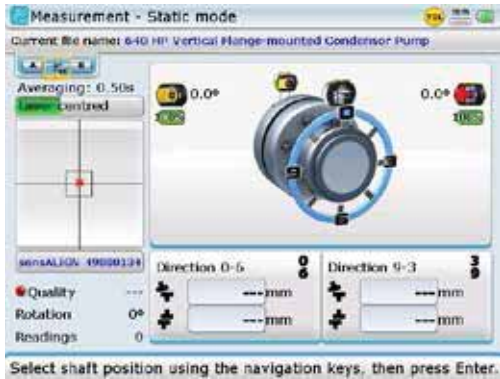

Select shaft position using the navigation keys, then press Enter.

2. Rotate the shafts to the first measurement position. If using the coupling housing numbering convention, the reference mark and the measurement position 0 should be aligned or matched to each other.
3. Press  to take the first measurement point.
4. Rotate shaft to the second measurement position (e.g. 1:30). If the chosen measurement position does not correspond to the position selected automatically on the display, use the navigation keys to manually position sensALIGN sensor and laser at desired position on the display.
5. Take the maximum number of measurement points to maximize the quality of results.

160

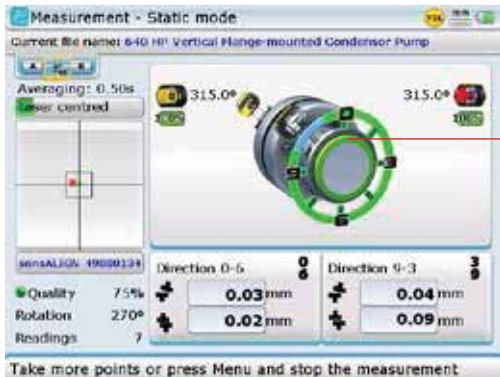

Take more points or press Menu and stop the measurement

In Static mode measurement, the inner ring displays the measurement quality which is active only when measurement is finished using the “Measurement” screen context menu item ‘Stop’. In this example, the measurement quality is good and therefore the colour code green.

6.3.5 Results

1. Press **RES** to evaluate results.

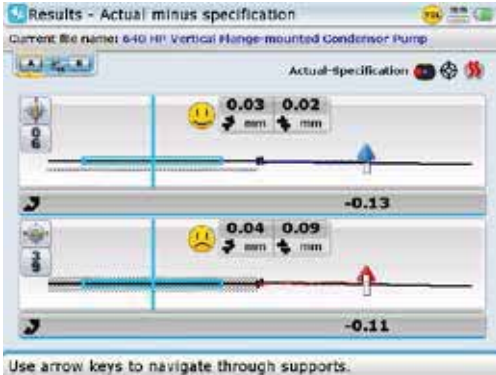

The results screen shows the coupling gap and coupling offset in the 0-6 and 3-9 directions. Offset corrections in the side and top view are also shown.

In this example, the 0-6 correction indicates moving the flange by 0.13 mm towards 0:00 and by 0.11 mm towards 3:00.

The screen values represent POSITION.

Sign convention

POSITIVE GAP opens towards 0:00 or 3:00

POSITIVE OFFSET if the top machine is towards 0:00 or 3:00

Remember, viewpoint is always determined by looking from the sensor towards the laser emitter. Note the little white clock face on the laser serves as a reminder of this.



2. Use the "Results" screen sub menu item 'Details' to view the shimming corrections for each flange bolt. Press **Menu** while in the results screen then use the navigation keys to highlight the submenu item 'Details'.

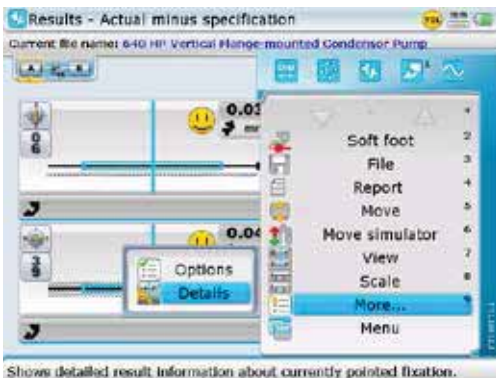

3. With 'details' highlighted, press **Enter** to confirm selection. The "Flange corrections" screen appears.

Flange correction details are displayed only when the cursor is on a movable element.



The flange corrections screen shows the shimming corrections for each flange bolt. The value for each bolt position appears on the shim table and as an inset next to the flange pattern. Any bolt position can be selected by pressing either $\ominus\oplus$ (counterclockwise) or \ominus/\oplus (clockwise).

Press RES to cycle through the 0-6, 3-9 and both results' views. The three views may also be accessed using the "Results" screen context menu item 'View --' where -- can be either 'both', '0-6' or '3-9'.

- To choose the shimming solution best suited for the situation at hand, press Menu while in the results screen. The context menu appears.

The offset corrections to be performed on the flange are displayed along the sides of the flange schematic.



Shows all corrections to provide the lowest correction magnitude.

Use the navigation keys to highlight the appropriate mode then press Enter to confirm selection.

- > $(-)$ mode indicates all negative shimming
- > $(+)$ mode indicates all positive shimming
- > (\pm) mode indicates optimized shimming. In this mode, half of the corrections will positive, and the other half negative.
- > $(0+)$ mode indicates zero plus shimming. In this mode, one bolt position is forced to zero and the rest are positive.
- > $(0-)$ mode indicates zero minus shimming. In this mode, one bolt position is forced to zero and the rest are negative.

Good quality shims such as PERMABLOC, MYLAR and LAMIBLOC should be used. Contact your local PRÜFTECHNIK representative for details.



- Offset is corrected using the 'Move' function. These corrections may also be simulated using the Move simulator. Both these functions may be accessed via the "Results" screen context menu. Press then use / to highlight the required Move function from the context menu that appears.

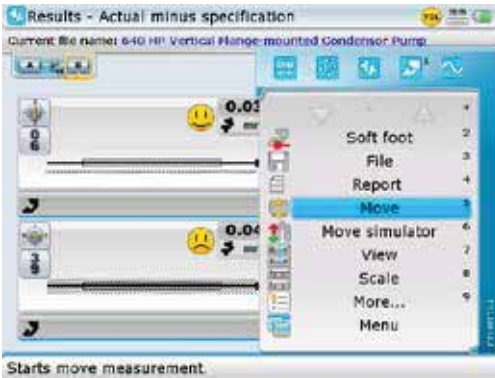

In this example, we will proceed with live Move. The context menu item 'Move' is highlighted using /.

The Move simulator is used to simulate flange offset corrections. Note that the simulated values may often not result in the alignment being within tolerance as shimming corrections are not considered in vertical alignment Move simulation. For details you may refer to section 4.14.2a-b.

- With the context menu item 'Move' highlighted, press to confirm selection. A hint requesting the setting of the sensor angle appears on the screen.

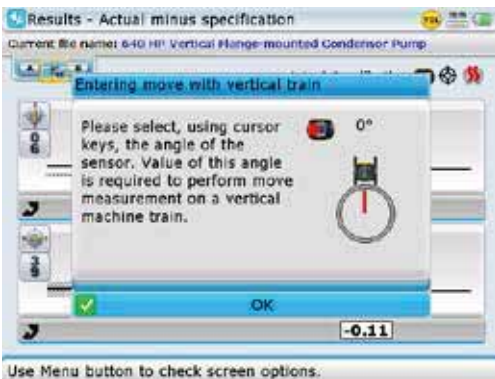

- Use the navigation keys to position the sensor image on the screen to correspond to the angular position of sensALIGN laser and sensor. Press to confirm selected position. The Move function auto starts.

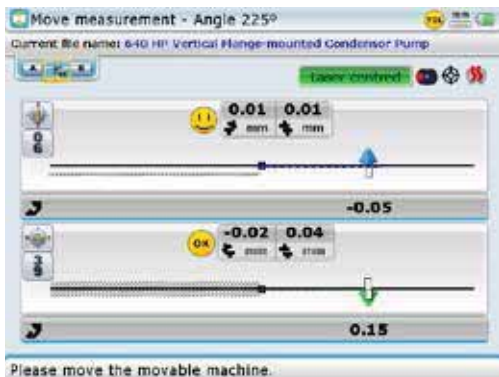

If the Move function does not auto start, the beam is not centered. Use the “Move measurement” screen context menu item ‘XY view’ (see section 5.2.8) to center the laser beam, then press \odot and wait for the Move function to auto start.



Note

6.3.6 Alignment

It is recommended (but not necessary) to correct angularity first:

1. Loosen the flange bolts and lift the movable machine to a small degree.
2. Adjust shimming to make angularity corrections:
 - › For face-mounted flanges, insert the indicated thickness of shims between the flanges at the respective bolt locations.
 - › For reverse-mounted flanges, insert the indicated thickness of shims behind the flanges at the respective bolt locations.
3. Tighten the bolts back down, then take another set of readings to confirm alignment corrections; repeat shimming if necessary.
4. Once satisfied that overall angular misalignment is in tolerance, and no more shimming is required, proceed to correct offset.

Correcting offset misalignment:

5. Press Menu while in the results screen. Preferred is a results screen showing both 0-6 and 9-3 alignment results [use RES to cycle through the three different views].
6. From the context menu that appears, access live Move by using Δ / ∇ to highlight ‘Move’ then confirming selection by pressing Enter .
7. Ascertain at which position sensALIGN laser and sensor are located or turn them to any desired position. Use the navigation keys to match the sensor position on the screen to the physical position of the laser and sensor. Confirm selected position by pressing Enter .

8. Loosen the flange bolts and perform offset corrections in the 0 to 6 and 9 to 3 o'clock directions while monitoring the live Move on the screen.
 - › Corrections should be brought as close as possible to zero.
 - › Use appropriate tools (e.g. jackscrews) to position the machine.
 - › Take care not to let the shims slip out of place during lateral positioning.
9. When offset is in tolerance, tighten the flange bolts. Remeasure to check if the new alignment condition is in tolerance.
10. If not, repeat the above steps until alignment is in tolerance.

6.4 Flange-mounted horizontal machines

When machines are joined by means of flange, their alignment is determined by inserting the proper combination of shims at the flange bolts and, depending on the flange type, between the faces of the flanges. The requirements are quite similar to those for aligning vertical machines.

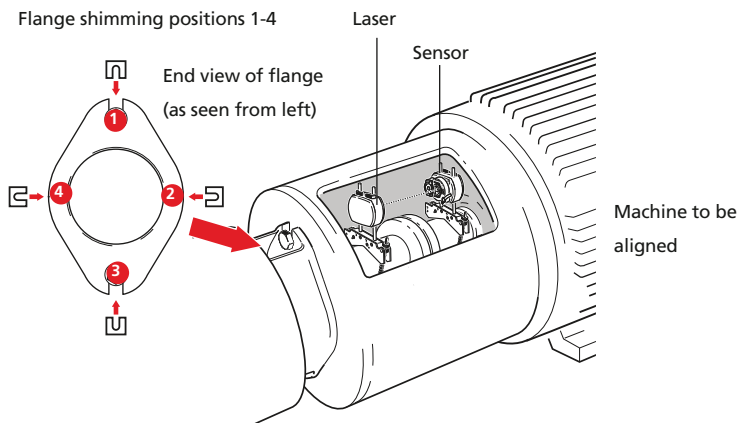

When the shaft rotates around a horizontal axis, the electronic inclinometer detects the rotational position during measurement, which may be taken in any desired measurement mode.

Based on the measurements taken, the computer determines the thicknesses of shims to be fitted between the flanges required to align the shafts.



Shown here are the shimming locations for a two-bolt flange, a special case of the normal circular flange shape.

6.4.1 Set-up

1. Mount sensALIGN laser and sensor on the shaft. sensALIGN laser mounts on the left machine and sensALIGN sensor on the right. This arrangement is identical to the standard ROTALIGN Ultra iS screen display for horizontal machines.
2. Switch ROTALIGN Ultra iS on by pressing  and holding for a few seconds. When the program manager screen appears, use the navigation keys to highlight 'Shaft Alignment'. Press  to access the application. The opening template in the set-up screen appears.

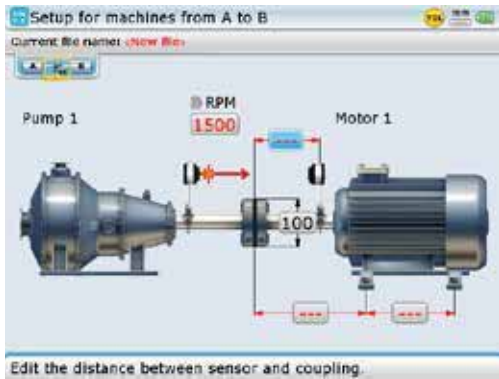

Configure the machines directly from this screen as described in sections 4.7 – 4.9.

The screen opposite will appear only if the customization option 'Resume policy' has been set to 'Resume files manually'. (See customization – described in section 8.1.11)

3. Important in this configuration is the flange position and configuration. Edit these as described in section 4.8.

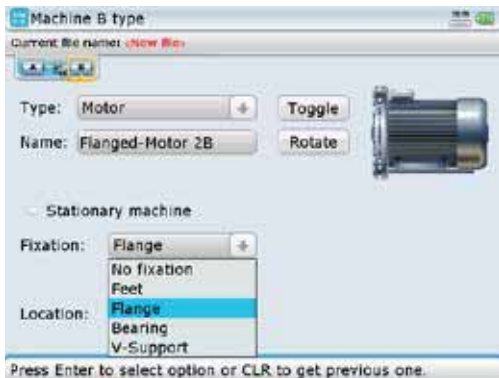

6.4.2 Flange geometry and dimensions

1. After configuring the machines, proceed to enter all necessary dimensions as described in section 4.7.

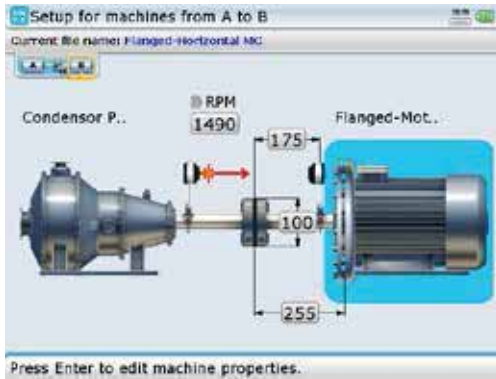

2. Edit the flange geometry by highlighting the flange-mounted machine then pressing . A hint requesting the definition of the flange appears. Confirm by pressing . The flange editing screen appears.

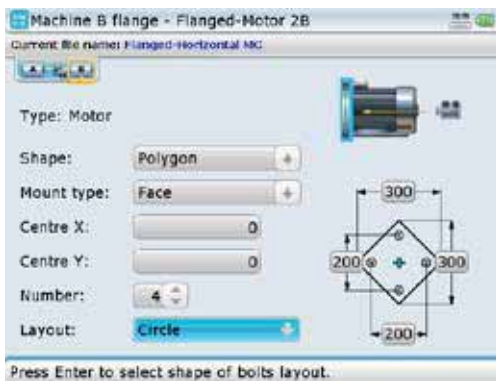

- c) Edit the flange geometry as described in section 6.3.3 previously (Set-up flanged machines).

6.4.3 Measure

Since the flanged machines under consideration here are mounted horizontally, a wider choice of measurement methods are available.

1. Press  and proceed to center the laser beam. The desired measurement method may be selected using the "Measurement screen" context menu item 'Measurement mode' (refer to section 5.1).
2. Depending on the measurement mode selected, rotate shafts and take measurement as described in section 4.12 (for intelliSWEEP measurement mode) or in section 5.1 (for other measurement modes).



In this example, the Multipoint measurement mode has been used.

6.4.4 Evaluating results

1. After finishing taking measurements, press  to evaluate results.

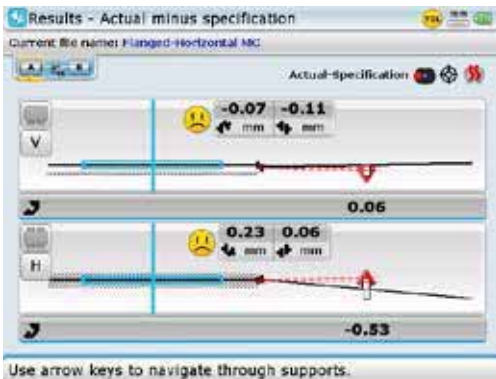

2. To view the flange shimming details, place the cursor on the movable element, then use the sub menu item 'Details' to display the shimming details. (This step has been described fully in section 6.3.5.)

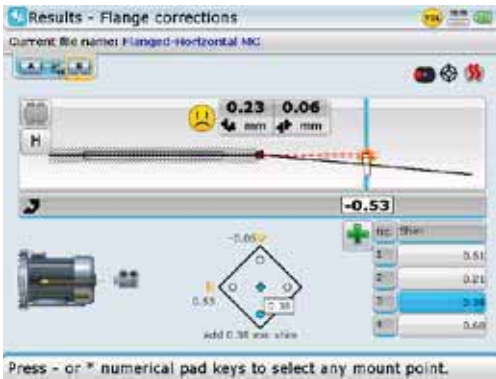

In this example, the horizontal offset value is 0.06 mm positive. The table on the right lists the calculated shim corrections. The interpretation of the shim corrections has been described in section 6.3.5.

The flange is depicted as viewed from the right machine toward the left. The bolts in the figure correspond to the bolts (or shimming positions) on the flange, with the top position corresponding to number "1". The respective offset appears on the top half of the screen.

6.4.5 Shimming

Loosen the bolts and fit the shims according to the values given in the table. Try to avoid any lateral movement of the machine while doing so. When finished, retighten bolts.

6.4.6 Remeasure

Press  and take a new set of readings before beginning offset corrections. The results should now show little if any shimming corrections.

6.4.7 Live Move to eliminate offset

Start live Move using the "Results" screen context menu item 'Move'.

Do not loosen the machine anchor bolts until live Move starts. Move the machine laterally (for horizontal) while viewing the screen.

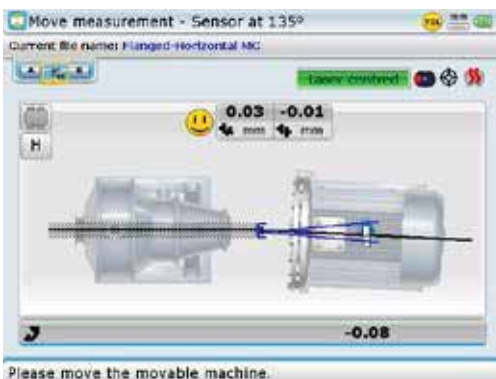

Jack bolts or other mechanical or hydraulic adjustment methods are recommended for best results. Tighten down the anchor bolts, then press  to conclude the horizontal alignment procedure.

6.4.8 Final check

Press  and take another set of readings in order to confirm the alignment condition.

Remove the components from the shaft before switching on the machine!



WARNING

Chapter 7: Updating ROTALIGN Ultra firmware

7.1 Updating ROTALIGN Ultra firmware to higher version

Current ROTALIGN Ultra firmware updates are carried out with the use of the approved PRÜFTECHNIK USB memory stick (aka jumpdrive) ALI 4.451.

Old PRÜFTECHNIK memory sticks must be disposed of in accordance to the directive on Waste Electrical and Electronic Equipment (WEEE).



The current firmware version may be downloaded from the PRÜFTECHNIK website.

7.1.1 Downloading the update from the PRÜFTECHNIK website

1. Go to: <http://www.pruftechnik.com/alignment-systems/press-and-downloads/software-and-firmware-downloads/rotalign-ultra.html>.

Download the update to a folder on the PC. It is a large file, this may take several minutes.

DO NOT download directly to your approved memory stick!

If an update had previously been carried out using the memory stick, it must be ensured that all old folders on the memory stick are deleted.



7.1.2 Transferring update files to the memory stick

1. Connect the approved PRÜFTECHNIK memory stick with not less than 110 MB of free space to the PC. Double-click the "ROTALIGN_Ultra_Firmware_3.0x.exe" file on the PC. A hint to extract the file to a memory stick appears (see the next screen).



2. Select the location of the memory stick with 'Browse', then click 'Install'. The files extraction process begins.

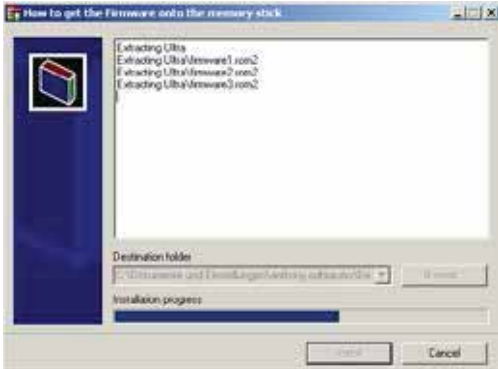

3. If the extraction has been successful, the update is now on the memory stick. Proceed to section 7.1.3 – 'Carrying out the firmware update'.

7.1.3 Carrying out the firmware update

Before starting the update verify that your memory stick has the files shown below in the 'Ultra' directory.

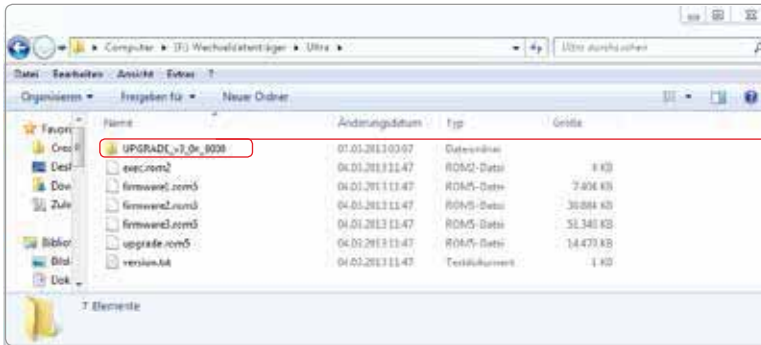

Note that this folder name corresponds to the downloaded firmware version.
Note that this folder is empty but necessary.

1. Connect the ROTALIGN Ultra iS computer to the mains adapter/charger, or ensure that the rechargeable battery is fully charged.
2. Switch ROTALIGN Ultra iS computer on and wait for Program Manager screen to appear.



3. Attach the 'short' USB/peripheral devices cable ALI 12.503 to the ROTALIGN Ultra iS .
4. Insert the approved PRÜFTECHNIK memory stick ALI 4.451 into the 'short' USB cable.





Approved memory stick inserted in the 'short' USB cable ALI 12.503 which is connected to the ROTALIGN Ultra iS computer.

5. On inserting the memory stick, ROTALIGN Ultra beeps and all 4 alignment condition LEDs blink followed by the next screen below



Should the firmware on the memory stick be of the same version as that present on the instrument, the instrument beeps and the 4 LEDs will blink but no update action will take place.

An update process is about to be started, therefore, pay special attention to the hints appearing on the display. Do not remove the memory stick during the entire upgrade process. This may take up to 15 minutes. To start the update process, press and hold down  until the device resets. Ignore the message that pops up asking whether you really wish to turn off the instrument or not—simply continue to hold down  until the computer turns off and turns on again. The entire reboot process can take as long as 20 seconds.



- The "Flashing firmware" screen as shown next appears with the hint not to turn off the device.





The following messages appear on the numbered locations on the screen opposite:
 1 "Flashing firmware... Do not turn the device off"
 2 "flashing firmware 1"

- When the final flashing phase is completed, the hint "Verifying the last firmware upgrade flashing" appears on the display with the 4 LEDs blinking continuously.
- After the automatic update is completed, the next screen appears.



9. Press and hold down  until the device resets. This is indicated with a beep and the blinking of the 4 LEDs.
10. After reset, the "Flashing firmware" screen appears again followed by the loading of the program manager. The update is now completed and the 'short' USB cable may be disconnected from ROTALIGN Ultra.
11. The new firmware version may be confirmed via the "Device information" screen. This screen may be accessed via either the 'Application information' or 'Application options' icons (refer to section 8.1.7 'Device info'). Alternatively, use the global menu items 'Configuration' / 'Device information'.



Access the global menu by pressing  twice the use the navigation keys and highlight 'Device information'. Confirming selection by pressing  opens the "Device information" screen.

Page intentionally left blank

Chapter 8: ROTALIGN Ultra iS Shaft configuration

8.1 Configuration

From the “Program Manager” screen use the navigation keys to highlight the icon ‘Configuration’.

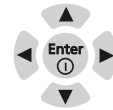

Press  to reveal the items used to configure the ROTALIGN Ultra iS computer.



The “Configuration” screen allows the following computer settings to be made:

- ‘Date and time’, ‘Language’,
- ‘Dimension and temperature units’, ‘System power management’, ‘Printer set-up’, Display brightness’,
- ‘Word completion’ and
- ‘Customization’.

The “Configuration” screen may also be used to access the following screens:

- ‘Licence manager’ – used to licence different applications ,
- ‘RFID options’
- ‘Bluetooth options’ – used to search the neighbourhood for Bluetooth devices; the screen’s context menu item ‘Bluetooth OFF’ may used to enable or disenable the Bluetooth capabilities of ROTALIGN Ultra iS computer.

8.1.1 Setting date and time

Accessing this section allows you to set the current date and time, choose the proper time zone, and change the date and time presentation formats.

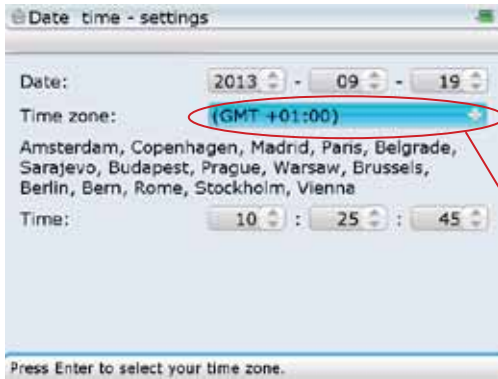

Use the navigation keys to select item to be changed.
To change digit values press then use to increase value or to decrease value.
A drop down menu is available for the selection of time zones.

To change the presentation format, press . The context menu appears.

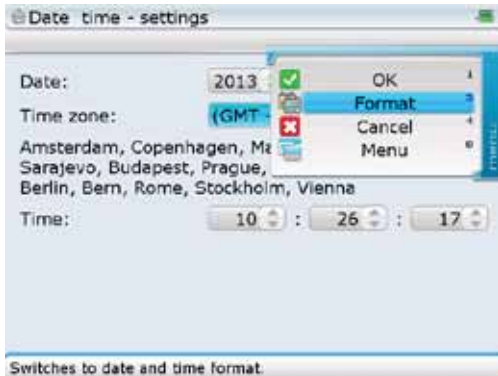

Use / to highlight 'Format' then press to confirm selection. The "Date and time format" screen appears.

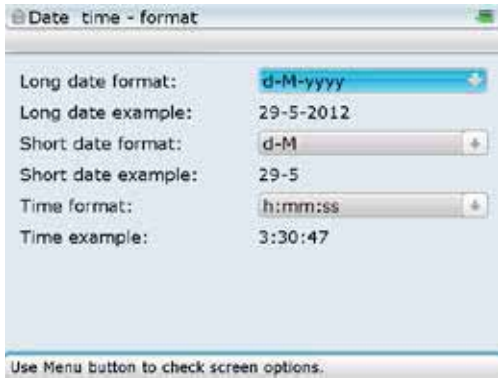

Use the navigation keys to move from one drop down menu to the next. When a drop down menu box is highlighted, press to display the available formats. Use / to highlight the desired format, confirming selection by pressing either or .

8.1.2 Language selection

Accessing this section allows you to select preferred country language.



The green check mark indicates the currently set language.

Use / to highlight preferred language. Press to confirm selection.

8.1.3 Setting units

Accessing this section allows you to change the dimensions and temperature units, as well as the resolution of units of measurement used in ROTALIGN Ultra iS. In this case, resolution is defined as the measurement precision in two or three decimal places.

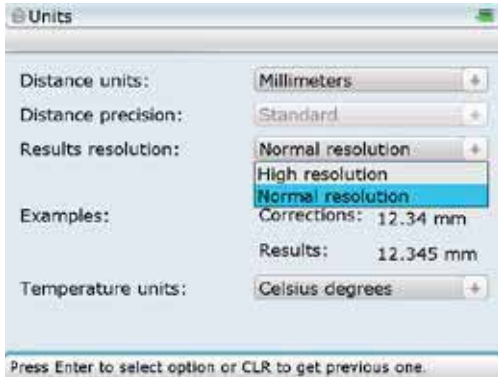

Use the navigation keys to move from one drop down menu to the next. When a drop down menu box is highlighted, press to display the available options. Use / to highlight the desired option, confirming selection by pressing either or .

Different system units can be configured by pressing while in the unit screen. The context menu appears.



Use / to highlight the preferred system of units. Confirm selection by pressing .

Sets units to inches, mills and Fahrenheit degrees.

8.1.4 Power management



This section displays the current battery status, allows you to control the power management features of shutdown, hibernate (sleep mode), and standby. The following suspend modes are available:

Suspend mode	Duration to standby (Dim)	Duration to hibernate (Sleep)	Duration to shutdown (Turn off)
Standard – this is the default mode	10 min.	20 min.	0 min.
Full power – the system does not go to standby or hibernate	0 min.	0 min.	0 min.
Presentation – system goes to standby after an hour	60 min.	0 min.	60 min.
Long life – system goes to standby rather quickly	3 min.	5 min.	10 min.
User defined – the standby, hibernate and shutdown times are user defined	—	—	—

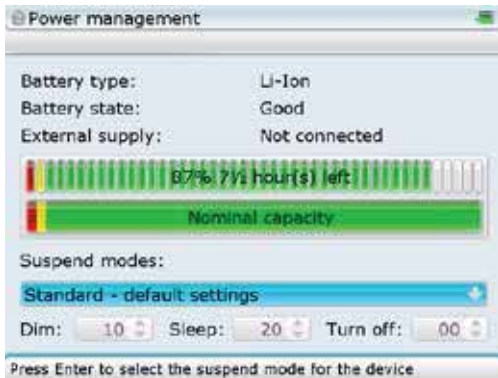

The recommended suspend modes are standard and full power.

To set standby and hibernate modes, press while in the "Power management" screen then use / to highlight required mode from the drop down menu that appears. Confirm selection by pressing or .

In hibernate, power is cut off completely while in standby it is not cut off completely.

A user defined suspend mode is also available. In this mode, the user may define the 'Dim', 'Sleep' and 'Turn off' value boxes are active, and the standby, hibernate and shutdown durations as required.

8.1.5 Printer set-up

Accessing this section allows you to set-up printers and the printing configuration on ROTALIGN Ultra iS.

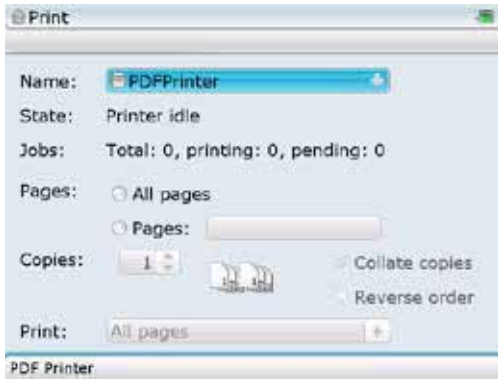

Select printer by pressing ,while in the "Print" screen then use / to highlight required printer from the drop down menu that appears. Selection is confirmed by pressing any one of these keys – or or or .

The default printer is 'PDF printer'. Using this printer setting, measurenet files are saved as PDF directly to a memory stick (aka a jump drive).

Not all commercially available printers are listed in the drop down list of selectable printers. If your model is not shown, select a similar type from the same brand and try it. If it does not work or your brand is not shown at all, then select 'Epson24PinGeneric'.



Use the navigation keys to scroll through the settings and print options. Press to select or edit an option or setting.

More printing options can be accessed by pressing while in the print screen. The context menu appears.

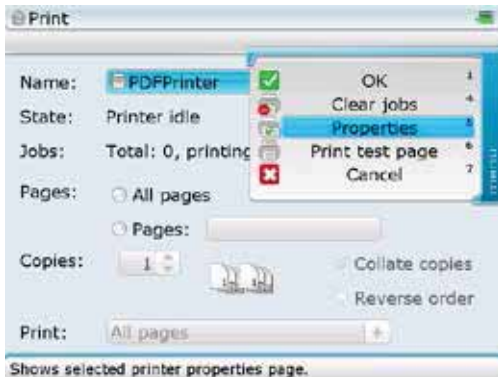

Scroll the context menu using / . Press to confirm selection. 'Properties' context menu item is used to access the screen where page size and page orientation may be set.

8.1.6 RFID options

The “RFID options” screen is used to access the options required when applying ROTALIGN Ultra iS RFID functionality.



The functions of the “RFID options” screen icons are self-explanatory. These are accessed using the navigation keys, then confirming selection by pressing .

For details on using RFID with ROTALIGN Ultra iS Shaft please refer to the RFID Guide DOC 04.600. en.

8.1.7 Bluetooth options

The primary use of the “Bluetooth options” screen is to connect (aka pairing) Bluetooth devices to the ROTALIGN Ultra iS computer. When connected (or paired), measurement reports may be sent from the ROTALIGN Ultra iS computer to the Bluetooth device (which could be a smartphone or a tablet PC).

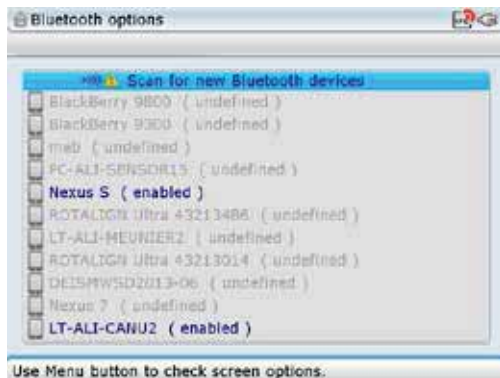

Use / and highlight ‘Scan for new Bluetooth devices’. Confirm selection by pressing . Any detected Bluetooth device will be listed on the screen and measurement reports may be transferred to the device when enabled.

The screen is also used to enable or disable the ROTALIGN Ultra iS computer Bluetooth capabilities. When in the Bluetooth options screen, press to reveal the context menu items, then use / and highlight the item ‘Bluetooth OFF’.



The context menu item 'Bluetooth OFF' toggles with 'Bluetooth ON' depending on the current Bluetooth status.

Confirm selection by pressing . A hint appears on the display requiring confirmation as to whether Bluetooth should be turned off. Confirm selection after highlighting 'Yes'. After confirmation, restart the computer for the Bluetooth status change to take effect.

8.1.8 Device info

Accessing this section allows you to see the current file space and operating memory statistics, the CPU data, the ROTALIGN Ultra iS serial number, and information about the core software used in the device.



'Device information' is accessed via either the 'Application information' icon or the 'Application options' icon within the "Configuration" screen. When the "About Program Manager" screen or the "Applications options" screen appears, press . A context menu with the item 'Device information' appears.



Use / to highlight 'Device information'. Press to confirm selection and display device information.





ROALIGN Ultra iS serial number

8.1.9 Display brightness

Accessing this section allows you to change the brightness of the display screen.



The display brightness is adjusted using  (increases) or  (decreases).

185

8.1.10 Word completion

The word completion feature helps save keystrokes and time while typing. It also helps you to make sure that the misspelling of words is avoided. When a user begins the entry of a word already listed in the system dictionary, the word is completed automatically, and may be adopted by pressing .

The ROTALIGN Ultra iS computer word completion feature comes equipped with a set of predefined words. The mechanism allows entry of user defined words.

On initially starting the word completion feature, a hint advising on the non-existence of a user defined dictionary appears on the display.



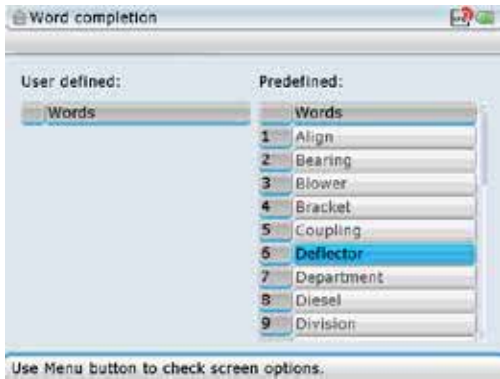

Initially, there is no user defined dictionary. The 'Word completion' screen displays a predefined choice of words available for the automatic completion mechanism. The predefined words' column is scrolled using \leftarrow / \rightarrow while the user defined words' column is scrolled using \triangle / ∇ .

To add, delete or test the completion feature, press Menu . The context menu appears.



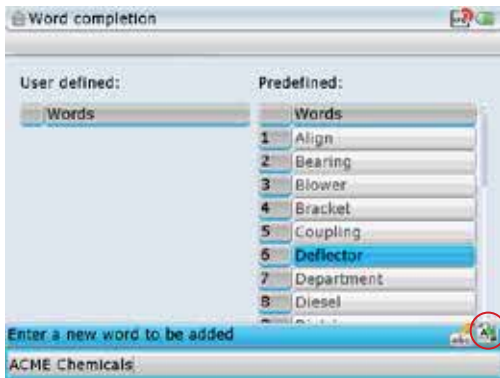

Use \triangle / ∇ to highlight action required from the context menu, then confirm selection by pressing Enter .

186 New additions are made in the 'User defined' column only. To do this, use \triangle / ∇ to highlight 'Add'. Press Enter to confirm selection. Use the data entry keys to enter the new word in the dialog box that appears.



When entering user defined words that contain both upper and lower case characters, as well as numerals, use ./* to cycle through the three options. Press and hold down ./* while observing the status indicator at the top right corner of the dialog box. This displays the character to be entered.

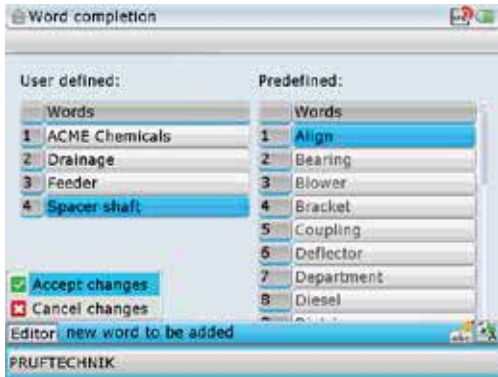

When entering letters, 0- is used to enter a blank space.

The new word is adopted within the user defined column by pressing either   or using the context menu item 'Accept changes' which appears when the dialog box open.



An additional editing facility is achieved using the dialog box menu bar items. The bar appears by pressing  when the dialog box is open.

The menu bar is navigated using the navigation keys.

To test if a word is available in the dictionary, use  /  to highlight the context menu item 'Test dictionary'. Press  to confirm selection. Use the data entry keys to enter the first letter of the word required. The word high up in alphabetical order will appear in the dialog box. Test further by entering the second letter. If necessary enter the third and fourth letters to confirm whether the word is available in the dictionary.



In this example, the letter 'G' has been entered first revealing that the word 'Gearbox' exists in the dictionary. If looking up the word 'Generator', we would be required to enter the first three letters ('gen') for results.

Addition and deletion of words is possible only with user defined words. Predefined words are not available for editing.







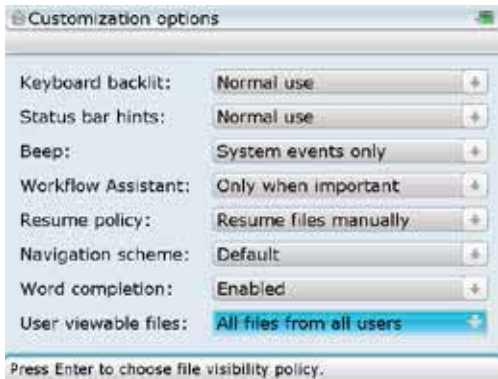

Note

8.1.11 Customization



Customization makes it possible to change the device settings such that the information displayed is suited to individual needs. These settings are carried out in the “Customization options” screen which is accessed by pressing  with the ‘Customization’ icon highlighted.



Select item to be customized by highlighting the respective item box using the navigation keys. Press  and use  /  to select desired setting from the drop down menu that appears. Confirm setting by pressing  /  or any of the navigation keys.

Options available include:

Keyboard backlight

Two options are available – backlight is set either ‘Off’ or in ‘Normal use’

Status bar hints

Four options are available – ‘Normal use’, ‘Never in menu’, ‘Only in menu’ and ‘Never’

Beep

The internal beeper can emit sound signals when specific tasks take place. The drop down menu reveals the following options:

‘Never’ – beeper is permanently off

‘System events only’ – the sound signal is emitted only when a system event occurs

‘Every key stroke’ – the sound signal is emitted when a system event occurs and each time a button is pressed

Workflow assistant

This option is used to provide hints to the user on how to proceed with using the system. Options available include – ‘Never’, ‘Always’, and ‘Only when important’

Resume policy

This option is useful for the resume functionality of ROTALIGN Ultra iS. The drop down menu reveals the following items:

‘Resume files manually’ – a new job is started by loading a default template

‘Always resume last file’ – the most recent job resumes automatically

Navigation scheme

There are two navigation options – ‘Default’ and ‘Editing moves focus’

This customization option is very important in that it determines how a user navigates through the system. It would be advisable to try out the different options to establish which option suits you best. In this operating instruction we will try to stay with the option 'Editing moves focus'.



Note

Word completion

Two options are available – 'Enabled' or 'Disenabled'

User viewable files

Two options are available – 'Only user files and templates' or 'All files from all users'

8.1.12 Measurement file backup



As an extra data storage capability, ROTALIGN Ultra iS Shaft measurement files may be saved and stored on memory devices such as memory sticks (aka jump drives) or on PCs.

The configuration item 'Backup user files' is used to create a backup file of all measurement files on any particular ROTALIGN Ultra iS computer.

Attach an approved memory stick to the USB/peripheral devices cable ALI 12.503 (short USB cable) then connect the USB cable to the ROTALIGN Ultra iS computer USB port (refer to figure below).

Highlight 'Backup user files' icon then confirm selection by pressing . The following hint appears.



Use  /  to highlight 'Yes' then press  to confirm selection.

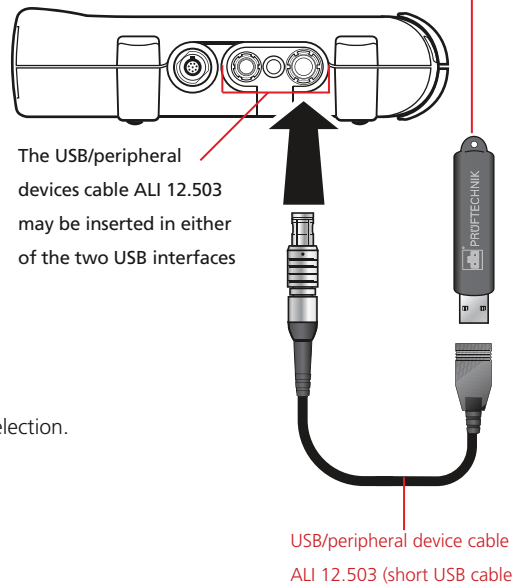

After backup completion, the following hint appears. Press  to confirm. You may now transfer the backup file to another storage device such as a PC.



The backup file is stored in the ULTRA directory.

8.1.13 Restoring user files

Measurement files saved and stored as backup may be restored to the ROTALIGN Ultra iS computer using the facility 'Restore user files'.

Attach the memory stick containing the backup file to the short USB cable ALI 12.503 then connect the USB cable to the ROTALIGN Ultra iS computer as described in the previous section 8.1.12. Select the "Configuration" screen icon 'Restore user file' then press  to confirm selection. A hint to give the user the opportunity to ascertain whether the backup restoration should proceed appears on the screen.



Use  /  to highlight 'Yes' then press  to confirm selection. A further hint appears on the screen





This final hint is to ensure that restoration of the backup file is carried out on the original ROTALIGN Ultra iS computer where the backup was made.

DO NOT restore backup files to a different computer other than the one which the backup file was created from.



Note

Use  /  to highlight 'Yes' then press  to confirm selection and transfer the backup file into the ROTALIGN Ultra iS computer.



The backup file is the ULTRA directory has been restored to the ROTALIGN Ultra iS computer..

8.2 User accounts

The ROTALIGN Ultra iS user accounts function enables multiple users to easily share a single device. Each user has a separate profile with unique settings and preferences, such as language and customization options (see sections 8.1.2 and 8.1.11 respectively). User accounts control which measurement files users can access and what types of changes users can make to the device.

A user account may be changed at any time using the global menu items 'Quit' -> 'User Account'. The "Global menu" screen is accessed at any time by pressing  twice.



The permission to add new users is granted to users logged on to ROTALIGN Ultra iS computer as administrator.



As a security measure, ROTALIGN Ultra iS computer offers three possible configurations.

- ▶ Computer is configured for all users with no login required. After switching the computer on, no login password is required.
- ▶ Computer is configured so that all users save for Administrator require no login password.
- ▶ Computer is configured so that all users save for Guest require a login password.

8.2.1 Log on ROTALIGN Ultra iS as administrator



Administrator rights include the capability to add new user accounts and access all other user accounts and measurement files.

To work with ROTALIGN Ultra iS computer as administrator requires the creation of an administrator password.

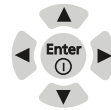
From the "Program Manager" screen use the navigation keys to highlight the icon 'User Accounts'.



192

Confirm selection by pressing , then use / to highlight the user 'Administrator'.







Confirm selection by pressing **Enter**. A hint advising the absence of a password will appear on the screen.





If the Administrator password had already been allocated, confirming selection opens the 'Enter a password to login' value box.

Use **Enter** and highlight 'OK' then confirm selection by pressing **Enter** or **l**. The password editing box with the instruction to enter new password appears.



After entering new password using the data entry keys, confirm entry by pressing  or . A new password editing box opens with the instruction to enter password again. Enter the password again then confirm entry by pressing  or . On confirming entry, a final password editing box appears with the instructions to enter the password to allow login.



After entering password to log in, confirm selection by pressing  or . The administrator profile will then be loaded.



After the profile has been loaded, administrator rights such as adding new user accounts or deleting existing user accounts may now be carried out.

If the Administrator password is ever forgotten or lost, please contact your local PRÜFTECHNIK representative for assistance. A temporary 'back door' password to the Administrator account can be supplied to authorized users upon request.



Note

8.2.2 Using administrator password

Using ROTALIGN Ultra iS computer as an administrator always requires a password to log on.





The administrator login screen always appears when the computer is turned on with the application option 'User accounts' activated to run at start-up.

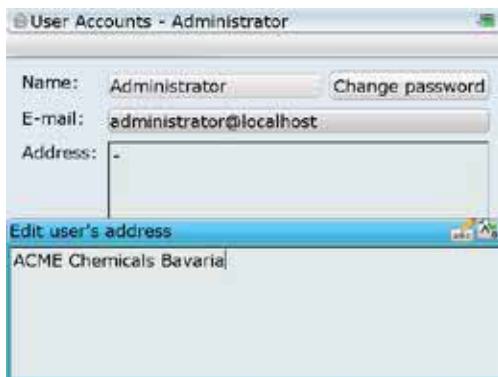

The computer may also be configured so that individual accounts are accessible only after entering a login password which is created by the administrator only.

The administrator password may be used to allow or deny access to the administrator profile. This is done by enabling or disabling the password.

To enable the password, enter the "User Accounts – Administrator" screen, then highlight the user 'Administrator'. Confirm selection by pressing .



The "User Accounts – Administrator" screen is accessed via the 'User accounts' icon, then selecting user 'Administrator', and confirming selection by pressing .

While in the above screen, press  to open the context menu. Use / and highlight the context menu item 'Enable password'.



Note that if password is already enabled, the context menu item toggles to 'Disable password'.

If the item 'Enable password' is selected and confirmed, then a login password will be required for all account users except for 'Guest' account.

Confirm selection by pressing **Enter**. With password now enabled, a password will be required to access the administrator profile every time ROTALIGN Ultra iS computer is switched on.

If however, the administrator is the only user of the device or company policy does not see the necessity of an administrator login, then the login screen may be skipped, and the administrator profile accessed directly whenever the device is turned on.

To remove the login screen, access the "User Accounts – Administrator" via the 'User accounts' icon. With user 'Administrator' highlighted, press **Enter**. A new screen with an address pane and 'change password' box appears. While on this screen, press **Menu** to open the context menu, then use **Down Arrow** / **Up Arrow** and highlight the context menu item 'Disable password'.



Confirm selection by pressing **Enter**, then proceed to access the "Applications options" screen via the "Configuration" screen.



The headers 'Visible' and 'Run at startup' signify the applications which will appear in the "Program Manager" screen and those items that will open when the computer is turned on.

While in the "Applications options" screen, use and highlight 'User Accounts', then press to open the context menu.



The "Applications options" screen is accessed via the 'Applications options' icon in the configuration screen. The item 'User Accounts' is visible to the administrator only. When disabled to run at start-up, a 'No' appears next to the item.

If password has been disabled in the "User accounts" screen and the 'Disable at startup' item is selected and confirmed, then all user accounts save for Administrator may be accessed without a login password.

Use and highlight the context menu item 'Disable at startup', then press to confirm selection. A 'No' will appear on the item's 'Run at start-up' column. On restarting ROTALIGN Ultra iS Computer, the administrator profile will be loaded automatically without prompting the administrator login.

8.3 Creating templates

A template is a file that serves as a pattern for alignment set-ups that are repeated frequently. Their main purpose is to save you time by not having to configure the same set-up many times. As such, it can contain all known dimensions, target specifications, thermal growth values, preferred measure mode, preferred machine icons and coupling types.

Any readings already taken and present in the measurement table will be flushed. Readings should only be saved in active job files and cannot be saved with a template.



Note

Start Shaft Alignment application and define template.

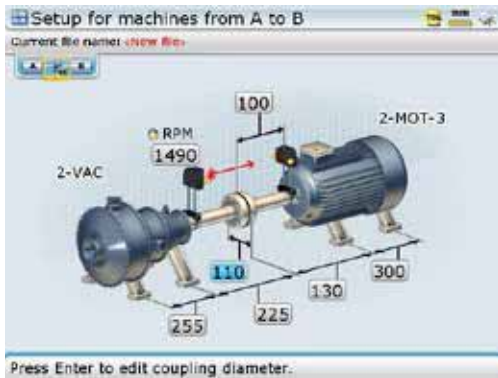

198

Press  twice to open the global menu.

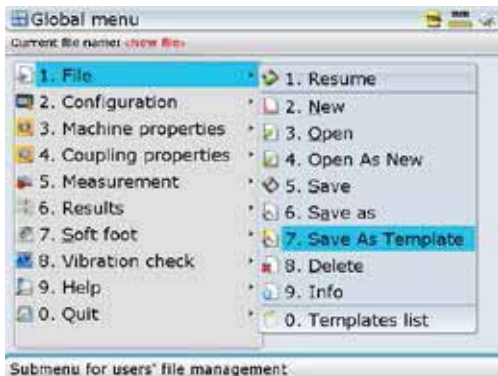

Use the navigation keys to highlight 'File' / 'Save as template'. Confirm selection by pressing **Enter**. The "Save as template" window appears. Press **Enter** to edit the name of the template in the editing box that opens.

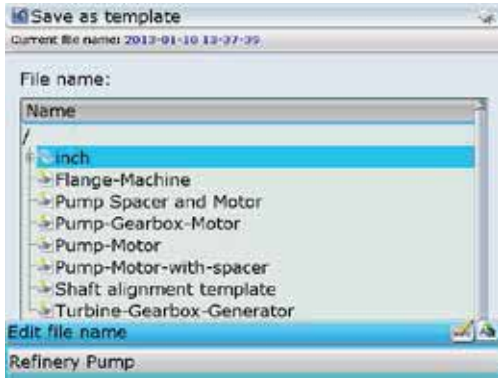



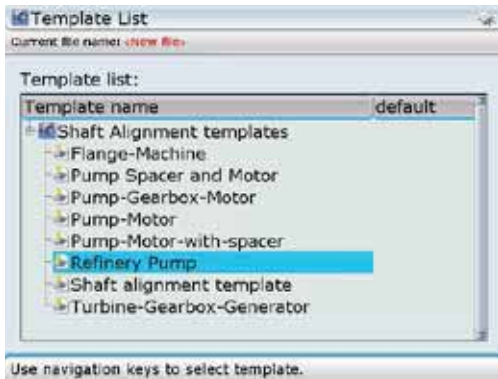

Press **Enter** to confirm template name and save template. The new template will now appear on the templates list. It is accessed via the global menu item 'Templates list'. Highlighting 'Templates list' from the global menu, then pressing **Enter** to confirm selection reveals the templates list.

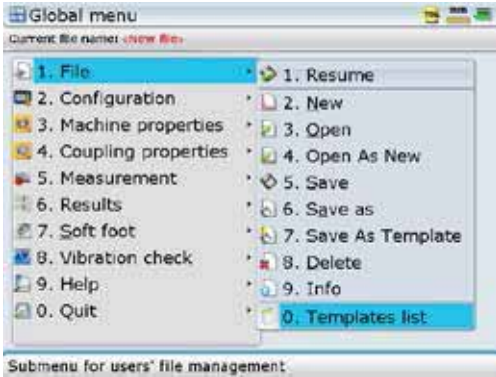

8.4 Deleting created templates from the program manager



Press  twice to open the global menu while in the Shaft Alignment application.



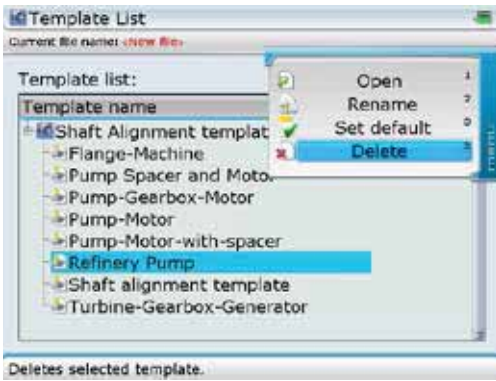

Confirm selection by pressing . The “Template list” screen opens. Use / to highlight the template to be deleted, then press  to open the screen context menu.



If you select a template and set it as the ‘default’ template, a working file based on this template will be started every time you launch the Shaft Alignment application. If you do not designate a default template, a working file based on the factory default template will launch instead.

With the context menu displayed, use / to highlight the item ‘Delete’. Confirm by pressing .

A message pops up requesting confirmation if the file should actually be deleted. Use / to highlight ‘Yes’ and confirm selection by pressing . The template is deleted from the templates list.

Alternatively, templates may be opened via the global menu items ‘File’->‘Open’, followed by the “Open document” screen context menu items ‘Template’/‘Template’.

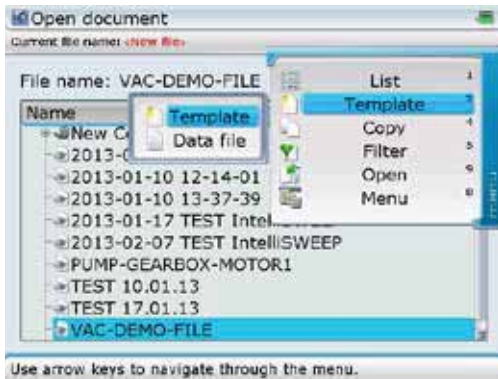





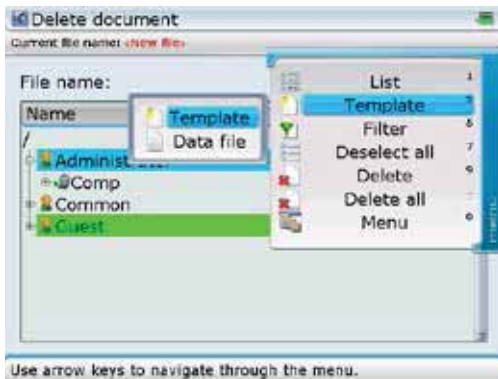

The templates list is revealed when selection is confirmed by pressing . Use / to highlight the template to be opened. You may open the template by pressing . The template could also be opened via the "Template list" screen context menu item 'Open'.

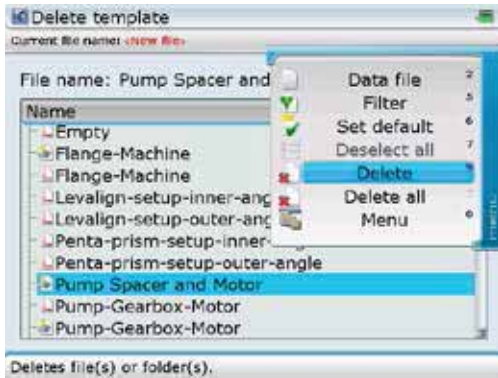
As an alternative, templates may also be deleted via the global menu items 'File'->'Delete', followed by the "Delete document" screen context menu items 'Template'/'Template'.



Confirm selection by pressing . The "Delete template" screen opens with a complete list of all available templates. Use / to highlight the template to be deleted, then press to open the screen context menu.



With the context menu displayed, use  /  to highlight the item 'Delete'. Confirm selection by pressing . A message pops up requesting confirmation if the file should actually be deleted. Use  /  to highlight 'Yes', then confirm selection by pressing . The template is deleted from the templates list.

8.5 Available applications and options



The following applications and options can be selected via the program manager start screen.

- i) Resume – Depending on the set customization option, the resume option loads a default template or the most recent job.
- ii) Shaft Alignment – used to position the centerlines of rotation of two (or more) machinery shafts in line with each other.
- iii) Straightness – used to measure straightness.
- iv) Flatness – used to determine levelness and flatness of surfaces.
- v) Bore Alignment – used for bore and turbine alignment.

- vi) Live Trend – used to monitor machine positional change
- vii) Vibration Acceptance Check – used to measure and evaluate the vibration level according to machine classification threshold
- viii) Hydropower – measure the alignment condition of a hydro turbines
- vi) Right angle check – used to measure perpendicularity.
- vii) Tolerance editor – used to define individual alignment tolerance levels in terms of any desired coupling alignment parameters such as offset and angularity.
- viii) Soft foot – starts soft foot measurement
- ix) Templates – used to select a specified template for a new measurement job.
- x) Device configuration – used to configure the ROTALIGN Ultra computer settings. When this option is selected, the following computer settings can be configured: date and time, language, units, power management, printer set-up, device info, display, owner info and users' list. The option is also used to open the licence manager, start the word completion function, customization, change users, backup and restore files.
- xi) Turn off – is used to turn ROTALIGN Ultra off.



Certain applications must be purchased and licenced. Applications and options that have not been licenced will appear in program manager grayed out.



Note

8.6 Upgrading from Standard Shaft to Advanced Shaft version

To benefit from all the ROTALIGN Ultra iS intelligent features, which are available only in Advanced / Expert Shaft, it is necessary to upgrade from ROTALIGN Ultra iS Standard to Advanced version. For this upgrade, only the Advanced Shaft firmware registration certificate ALI 4.741 needs to be purchased. Use the licence manager and the licence code supplied on the registration certificate to activate the ROTALIGN Ultra iS Advanced Shaft firmware.

After starting the licence manager, use  /  to highlight the application 'Shaft Alignment'. Press  and use the data entry keys to enter the licence code in the editing box.



Note that the "Licence Manager" screen may be used to activate all available Shaft applications.

204

Confirm entry by pressing either  or .



The suffix 'Advanced' appears next to the version number indicating successful registration.

On successful registration, the following features in addition to the standard features of ROTALIGN Ultra iS Standard will be available:

- ▶ Live simultaneous Move in both horizontal and vertical directions
- ▶ Soft foot diagnosis using the wizard
- ▶ Alignment of trains with up to 14 machines
- ▶ Measurement in Pass mode
- ▶ Standard Deviation
- ▶ Editable ellipse
- ▶ Thermal growth calculator
- ▶ Under- and over-constrained feet
- ▶ File and machine templates
- ▶ Vector tolerances
- ▶ History table





Also included are the following ROTALIGN Ultra iS intelligent features:



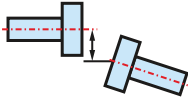

- ▶ IntelliSWEEP
- ▶ IntelliEXTEND
- ▶ IntelliPOINT
- ▶ IntelliPASS
- ▶ Intelli laser position
- ▶ Monitoring environmental vibration
- ▶ Vibration Acceptance Check
- ▶ Live quality filter
- ▶ Quality factors
- ▶ Determining live measurement quality
- ▶ Monitoring and suppressing coupling backlash
- ▶ Auto average

Page intentionally left blank

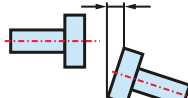
Appendix

Suggested shaft alignment tolerances

	[RPM]	metric [mm]		imperial [mils]	
Soft foot	any	0.06		2.0	
Short "flexible" couplings Offset 		Acceptable 	Excellent 	Acceptable 	Excellent 
	600			9.0	5.0
	750	0.19	0.09		
	1500	0.09	0.06		
	1800			3.0	2.0
	3000	0.06	0.03		
	3600			1.5	1.0
	6000	0.03	0.02		
	7200			1.0	0.5
	Angularity (coupling gap difference per 100 mm or 10" diameter) 	600			15.0
750		0.13	0.09		
1500		0.07	0.05		
1800				5.0	3.0
3000		0.04	0.03		
3600				3.0	2.0
6000		0.03	0.02		
7200				2.0	1.0
[continued]					

	[RPM]	metric [mm]		imperial [mils]	
		Acceptable	Excellent	Acceptable	Excellent
					
Spacer shafts and membrane (disk) couplings Offset (per 100 mm spacer length or per inch of spacer length)	600			3.0	1.8
	750	0.25	0.15		
	1500	0.12	0.07		
	1800			1.0	0.6
	3000	0.07	0.04		
	3600			0.5	0.3
	6000	0.03	0.02		
	7200			0.3	0.2

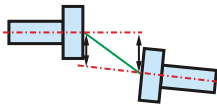

ROTALIGN Ultra iS technical data

ROTALIGN Ultra iS computer

CPU	Intel XScale® Processor 520 MHz
Memory	64 MB RAM, 64 MB Internal Flash, 1024 MB Compact Flash Memory
Display	Type: Transmissive (sunlight-readable) backlit TFT colour graphic display Resolution: Full VGA, 640 x 480 Pixel Dimensions: 5.7 inch (145 mm) diagonal Keyboard elements: Navigation cursor cross with up, clear and menu keys; Alphanumeric keyboard with dimensions, measure and results hard keys
LED indicators	4 LEDs for laser status and alignment condition 2 LEDs for wireless communication and battery status
Power supply	Operating time: 25 hours (using Li-Ion rechargeable battery) 12 hours (using disposable batteries) typical use (based upon an operating cycle of 25% measurement, 25% computation and 50% 'sleep' mode) Disposable batteries: 6 x 1.5 V IEC LR14 ("C") [optional] Lithium-Ion rechargeable battery: 7.2 V / 6.0 Ah
External interface	2 x USB host for printer, keyboard, USB stick 1 x USB slave for PC communication RS-232 (serial) for sensor RS-485 (serial) for sensor I-Data socket for sensor Ethernet Integrated wireless communication, class 1, transmitting power 100 mW AC adapter/charger socket
Environmental protection	IP 65 (dustproof and water jets resistant), shockproof Relative humidity 10% to 90%
Temperature range	Operation: 0°C to 45°C [32°F to 113°F] Storage: -20°C to 60°C [-4°F to 140°F]
Dimensions	Approx. 243 x 172 x 61 mm [9 9/16" x 6 3/4" x 2 3/8"]
Weight	1 kg / 2.2 lbs (without battery)
CE conformity	Refer to the attached CE compliance certificate attached in the appendix

sensALIGN sensor

CPU and memory	ARM Cortex™ M3 and 2GB Flash memory
Environmental protection	IP 65 (dustproof and water jets resistant), shockproof Relative humidity 10% to 90%
Ambient light protection	Optical and active electronic digital compensation
Temperature range	Operation: -10°C to 50°C [14°F to 122°F] Storage: -20°C to 60°C [-4°F to 140°F] Charging: 0°C to 40°C [32°F to 104°F]
Dimensions	Approx. 103 x 84 x 60 mm [4 1/32" x 3 5/16" x 2 3/8"]
Weight	Approx. 310 g [10.9 oz]
Measurement range	Unlimited, dynamically extendible (US. Patent 6,040,903)
Measurement resolution	1 µm
Measurement error	< 1.0%
Inclinometer resolution	0.1°
Inclinometer error	± 0.25% full scale
Vibration measurement	mm/s, RMS, 10Hz to 1kHz, 0 mm/s – 5000/f • mm/s² (f in Hertz [1/s])
External interface	Integrated Bluetooth® Class 1 wireless communication, RS232, RS485, I-Data
LED indicators	4 LEDs for laser adjustment, 2 LEDs for Bluetooth® communication and battery status
Power supply	Lithium Polymer rechargeable battery 3.7 V / 1.6 Ah 6 Wh
Operating time	12 hours continuous use

sensALIGN laser

Type	InGaAlP semiconductor laser
Beam divergence	0.3 mrad
Environmental protection	IP 65 (dustproof and water jets resistant), shockproof Relative humidity 10% to 90%
Beam power	< 1mW
Wavelength (typical)	635 nm (red, highly visible)
Safety class and Precautions	Class 2 according to IEC 608251-1; DO NOT stare into laser beam
Temperature range	Operation: -10°C to 50°C [14°F to 122°F] Storage: -20°C to 60°C [-4°F to 140°F] Charging: 0°C to 40°C [32°F to 104°F]
Dimensions	Approx. 103 x 84 x 60 mm [4 1/32" x 3 5/16" x 2 3/8"]
Weight	Approx. 330 g [11.6 oz]
Inclinometer resolution	0.1°
Inclinometer error	± 0.25% full scale
LED indicators	2 LEDs for battery status and laser transmission
Power supply	Lithium Polymer rechargeable battery 3.7 V / 1.6 Ah 6 Wh External mains supply
Operating time	70 hours continuous use [Li-polymer battery]

Carrying case

Standard	ABS, drop tested (2 m / 6 1/2 ft.)
Dimensions	Case dimensions: approx. 565 x 375 x 193 mm [22 2/9" x 14 3/4" x 7 7/12"]
Weight	Including all standard parts: approx. 9 kg [19.8 lb]

sensALIGN sensor and laser 'ON/OFF/CHARGE' workflow

Action	sensALIGN laser status	sensALIGN sensor status
With both laser and sensor OFF, press the 'On/Off' push button briefly	Laser turns ON	Sensor turns ON and measurement is POSSIBLE
Either laser or sensor connected to ROTALIGN Ultra iS computer using the sensALIGN sensor and laser cable ALI 4.921-2 (applied when the sensALIGN rechargeable battery ALI 4.960 has a very low capacity or has been removed due to clearance area restrictions)	Laser turns ON	Sensor turns ON and measurement is POSSIBLE
Either laser or sensor connected to mains supply using sensALIGN charger/adapter ALI 4.651-l with rechargeable battery ALI 4.960 attached	Laser switches to 'charge' mode and may be turned on by pressing the 'On/Off' push button briefly	Sensor switches to 'charge' mode and measurement is NOT possible. Measurement may be reactivated by pressing the 'On/Off' push button briefly
Either laser or sensor connected to mains supply using sensALIGN charger/adapter ALI 4.651-l with rechargeable battery ALI 4.960 detached	Laser turns ON	Sensor turns ON and measurement is POSSIBLE
With both laser and sensor ON, press the 'On/Off' push button and hold down for a few seconds	Laser turns OFF	Sensor turns OFF

Declaration of conformity

CERTIFICATE

Declaration of conformity

We, **PRÜFTECHNIK Alignment Systems GmbH**

Address **Freisinger Str, 34
85737 Ismaning
Germany**



Quality management system
certified according to ISO 9001

declare of our own responsibility that the products

Product name **ROTALIGN Ultra Computer with accessories**
 Product Order no. **ALI 4.202**
 Accessories Order no. **ALI 3.600 Sensor
 ALI 4.603 ROTALIGN Ultra rechargeable battery
 ALI 3.610 Laser
 ALI 4.621 Radio Modul
 ALI 4.900 sensALIGN sensor
 ALI 4.910 sensALIGN laser
 ALI 4.960 sensALIGN rechargeable battery**

Configuration **Laser- optical system for shaft alignment**

comply with the standards, directives and regulations

- Directive 2004/108/EC of the European parliament and the council of 15 December 2004 on the approximation of the laws of the member states relating to electromagnetic compatibility
- Directive 2006/95/EC of the European parliament and the council of 12 December 2006 on the harmonisation of the laws of Member States relating to the electrical equipment designed for the use within certain voltage limits
- Directive 1999/5/EC of the European parliament and of the council Directive of 9 March 1999 on radio equipment and telecommunications terminal equipment and the mutual recognition of their conformity
- DIN EN 61326-1; VDE 0843-20-1 Electrical equipment for measurement, control and laboratory use – EMC requirements – Part 1: General requirements (IEC 61326-1:2005); German version EN 61326-1
- DIN EN 61326-2-2; VDE 0843-20-2-2 Electrical equipment for measurement, control and laboratory use - EMC requirements - Part 2-2: Particular requirements - Test configurations, operational conditions and performance criteria for portable test, measuring and monitoring equipment used in low-voltage distribution systems (IEC 61326-2-2); German Version EN 61326-2-2

Ismaning,

17.7.2012

Michael Stolze
managing director

Index

Symbol

0 0739 1055

- Allen key (2.5 mm) 8
- 2.5 mm allen key 22
- 3-D format 40

A

- Adjusting laser beam 24
- Administrator rights 192
- Advanced
 - Shaft level 83
- Advanced Shaft 143
- ALI 2.113 SET
 - Compact chain-type bracket set 7
- ALI 2.874 SET iS
 - cardan shaft bracket lite 147
- ALI 2.905
 - Lens cleaning cloth 7
- ALI 3.588
 - Tape measure mm/inch 7
- ALI 4.201
 - ROALIGN Ultra iS stand 5
- ALI 4.202
 - ROALIGN Ultra iS computer 5
- ALI 4.410
 - dust cap
 - computer sensor socket 9
- ALI 4.451
 - approved memory stick 171
 - USB memory stick 8
- ALI 4.603
 - ROALIGN Ultra iS
 - rechargeable battery 5
- ALI 4.605
 - ROALIGN Ultra iS
 - disposable battery housing 9
- ALI 4.615
 - ROALIGN Ultra iS
 - Desktop charging station for ALI 4.603 9
- ALI 4.615 SET
 - charging station with battery 9
- ALI 4.651-I
 - sensALIGN charger/adapter 6
- ALI 4.741
 - Advanced Shaft
 - firmware certificate 85
 - ROALIGN Ultra Advanced Shaft
 - Firmware registration certificate 8
- ALI 4.820
 - ROALIGN Ultra iS case 5
 - ROALIGN Ultra iS Shaft case 25
- ALI 4.900
 - sensALIGN sensor 5
- ALI 4.905
 - Vibration check probe 8
- ALI 4.910
 - sensALIGN laser 5
- ALI 4.921-2 19
 - sensALIGN sensor and laser cable 6
- ALI 4.960
 - sensALIGN rechargeable battery 5
- ALI 12.502
 - long USB cable 19
- ALI 12.502-2
 - PC/USB cable 6
- ALI 12.503
 - short USB cable 19
 - USB/peripheral devices cable 6
- ALI 12.651-I 19
 - AC power supply/charger 6
 - mounting/dismounting 18
- ALI 13.700 CD
 - ALIGNMENT CENTER CD 8
- ALI 40.000
 - ROALIGN Ultra iS Shaft package 5
- ALI 40.000-L
 - ROALIGN Ultra iS
 - Standard Shaft package 5
- Alignment condition LEDs 16
- Anchor peg 38
- Angularity 207
- Appendix 207
- Application levels 36
- Automatic completion mechanism 186
- Auto measurement 34
- Averaging 73, 108, 115
 - auto 115
- Averaging duration 87

B

- Batteries
 - replacing 17
 - standard 'C' size 17
- Battery compartment (optional)
 - ALI 4.60 16
- Battery status 20
- Battery status LED 16, 21
- Beam adjustment LEDs 24
- Beam position thumbwheel 20
- Beam position thumbwheels 54
- Bluetooth 121
 - disable 183
- Bluetooth communication LED 16
- Bluetooth devices 57
 - pairing 183
- Bluetooth OFF 177
- Bluetooth options 177, 183
- Bluetooth status 184
- Bolt coordinates 159
- Brackets
 - mounting 38
- Brightness 185
- Bulls-eye 54, 148

C

- Calibration 25
- Cardan bracket
 - faceplate 147
 - laser holder assembly 148
- Cardan drives 147
- Cardan shaft
 - units 154
- CE compliance 11
- Charger/adaptor socket 20
- Charger socket 19
- Check mark 36
- Clamping lever 23
- Clamping levers 39
- Compact chain-type bracket 38
- Component labelling 13
- Computer LEDs 16
- Configuration 177
- Conformity 212
- Context menu items 30
- Continuous Sweep 83
- Continuous Sweep mode 58
- Coupling properties 47

- Coupling targets 49, 127
- Coupling type
 - cardan shafts 126
 - short flex 126
 - single plane 126
 - spacer shaft 127
- Customization 40, 44, 188

D

- Data entry keys 15, 46
- Date and time 178
- Deactivating measurement points 104
- Default printer
 - PDF 182
- Default view 63
- Delta angle 109
- Device info 175
- Device information 184
- Dial gauge measurement 83
- Dial gauge mode 92
 - converting dial gauge readings 92
 - converting measurement table readings
 - dial gauge readings 96
- Dial gauge readings
 - conversion 92
- Dictionary
 - user defined 185
- Disposal 26
- Distance marking 42
- Distance plate 148
- DOC 04.600.en
 - Guide to using RFID 183
- DOC 40.100.en
 - ROTALIGN Ultra iS Shaft
 - pocket guide 7
- DOC 40.200.en
 - ROTALIGN Ultra iS Shaft
 - operating instructions 7
- DOC 40.900.en
 - ROTALIGN Ultra product catalog 7

E

- Editing box 41
- Editing label 100
- Edit raw data 87, 103
- Electromagnetic compatibility 11
- Elliptical flange 158

Expert
 Shaft level 83
 Expert Shaft 143
 Extending measurement range 105

F

FDA specifications 12
 File backup 189
 Firmware registration certificate
 Advanced Shaft
 ALI 4.741 35
 Flange geometry 167
 Flange-mounted machines 155
 Flange properties 158

G

Getting started 27
 Global menu 28, 30, 31, 103

H

Half function 112
 Hex screw 22
 History label 101

I

Identifying history labels 101
 IntelliEXTEND 107, 205
 Intelligent features 61, 205
 Intelli laser position 110, 205
 IntelliPASS 83, 88, 205
 intelliPOINT
 measurement mode 152
 IntelliPOINT 83, 90, 205
 intelliSWEEP 27
 IntelliSWEEP 58, 83, 84, 205
 IntelliSWEEP features 84
 IP 65
 computer rating 11

J

Job preparation 36

L

Label
 service and calibration 13
 vibration check probe 13

LAMIBLOC shims 163
 Language 179
 Laser
 Class 2 12
 Laser aperture 20
 Laser end
 Extend 105
 Laser safety 12
 Laser version check 109
 Latching nipple
 power supply plug 18
 Lateral positioning 74
 Lens cleaning cloth
 ALI 2.905 25
 Licence code 35, 36
 Licence manager 35
 Licence version
 Expert 83, 85
 Live Move
 concurrently 73
 Live MOVE 72
 Live Trend 127

M

Machine dimensions
 enter 41
 Machine names
 upper and lower case characters 44
 Machine orientation 43
 Machine trains 141
 Magnetic sliding bracket
 ALI 2.230 89
 Mains plug
 mounting/dismounting 18
 Measurement
 heads 88
 Measurement ellipse 104
 Measurement factor 84
 Measurement history 99
 Measurement mode 58
 Measurement modes 83
 Measurement points
 automatic collection 117
 Measurement quality 59, 153
 Static mode 160
 Measurement table 97
 maximum measurements stored 98
 Measurent table
 deleting measurement 101

Measuring vibration 118
 Memory stick
 ALI 4.451 78
 Mounting
 sensALIGN laser and sensor 39
 Move simulator 163, 68, 65
 options 71
 Move step 68
 'Move step' value
 default 69
 Multiple machine trains 142
 Multipoint measurement 86
 MYLAR shims 163

N

Navigation 44
 shortcuts 30
 Navigation keys 15, 28, 80, 87, 178
 Needle indicator
 on-screen 91
 Nonrotatable shaft 89
 Nonrotatable shafts 58

O

'On/Off' push button 60
 On-screen needle indicator 90
 Operating keys 15

P

Pairing
 Bluetooth devices 80
 Password 194
 administrator 195
 disable 196
 enable 195
 PDF file 78
 PERMABLOC shims 163
 Plug mounting 6
 Power management 181
 user defined 181
 Power supply 16
 Printer set-up 182
 Printing
 reports 79
 Program Manager 177
 Program manager screen 31

Q

Quality factors 86, 205

R

Real-time values 59
 Rechargeable battery
 ALI 4.603 17
 sensALIGN laser/sensor
 Lithium Polymer 20
 Reference surface 147
 coupling 148
 Repeatability 89
 Restoring user files 190
 Results resolution 117
 RFID options 183
 ROTALIGN Ultra iS
 Expert platform
 multiple coupling 146
 RPM 50, 51, 128

S

Safety notes 11
 Save
 file 82
 Saving
 files 75
 report as a PDF 77
 Scaling 64
 machine graphics 63
 sensALIGN laser
 ALI 4.910 12
 sensALIGN laser dust cap 54
 sensALIGN laser rating
 IP 65 20
 sensALIGN laser status 211
 sensALIGN sensor/laser cable
 ALI 4.921-2 60
 sensALIGN sensor socket 60
 sensALIGN sensor status 211
 Sensor selection 56, 61
 Sensor socket 19
 Sensor version check 109
 Shimming 67, 73
 Shimming mode
 vertical mounted machines 162
 Shims
 good quality
 PERMABLOC, MYLAR or LAMIBLOC 73

- Sign convention 66, 67, 127
 - vertical mounted machines 161
- Sliding dust cap 23
- Smiley 67, 128
- Soft foot 207
 - angular 133
 - checking and correcting 134
 - parallel 133
- Soft foot wizard. 138
- Spacer shafts 208
- Stabilization time 153
- Standard deviation 59, 87
- Static measurement 87
- Storage
 - ROTALIGN Ultra iS
 - computer 25
- Support angle
 - 2-D 124
- Support posts 38
- Symbols 11
- System of units 180

T

- Tape measure lip 42
- Target specifications 63
- Technical data 209
 - sensALIGN laser 210
 - sensALIGN sensor 209
- Templates
 - creating 198
 - deletion 200
- Thermal growth 46
- Thermal growth calculator 131
- Time zone 178
- Tips and tricks 32
- Toggle button 43
- Tolerance
 - acceptable 207
 - excellent 207
- Tolerance envelopes 63, 69
- Tolerances 67, 128
 - alignment 207
 - asymmetric/non-symmetrical 130
 - symmetrical 130
- Tolerance table
 - cardan shaft 154
- Tolerance values 50
 - maximum 51
- Train orientation 157
- Type of machine 43

U

- Uncoupled mode 88
- Uncoupled shafts 58, 89
- Unfixed feet pair 62
- Units 180
 - temperature 180
- Universal battery charger
 - ALI 12.651-I 16
- Updating
 - ROTALIGN Ultra firmware 171
- Upgrading
 - Standard Shaft to Advanced Shaft 204
- USB cable
 - ALI 12.503 173
- USB host/slave port 19
- USB/peripheral devices cable
 - ALI 12.503 78
- User account
 - changing 191
- User accounts 191

V

- Vertical alignment
 - Mounting sensALIGN laser 157
 - mounting sensALIGN sensor 157
- V-foundation 123
- Vibration check probe
 - ALI 4.905 118, 120
 - usage 120
- V-shaped support 46
- V-shaped supports 124

217

W

- WEEE
 - Directive 26
- WEEE Directive 26
- Word completion 185

X

- XY view 135
- XY View 106, 108

Z

- Zoom out 143

